



Introduction

Dear Customer,

We are pleased to present our new catalogue of safety cabinets for the storage of chemicals in industries, laboratories or communities.

We hope that this tool will facilitate your search and the suitable choice of our products.

CHEMISAFE products comply with the highest European standards and they guarantee you quality and safety without compromise:

- **EN14470-1** for storage cabinets of inflammable liquids
- **EN14470-2** for storage cabinets of gas cylinders
- **NFX 15-211** for chemical hoods and recirculation filtering cabinets
- **EN16121** for all our cabinet program
- **EN61010** for storage safety cabinets of chemicals

Our factory, located near Venice in Italy, has obtained **ISO 9001:2008** certification by Bureau Veritas. A continuous quality control of our production is ensured by a recognized and independent institute.

The marketing of CHEMISAFE products is ensured by a network of skilled and local partner distributors, which is always at your disposal. Our permanent technical and commercial support assesses your needs and recommends optimal solutions.

For your safety, do not risk and choose quality!

CHEMISAFE is:

- The certainty of having an experienced manufacturer with you
- The assurance of a dedicated and professional team who will give you the best advice

Yours sincerely,
CHEMISAFE

INTRODUCTION

3

STORAGE CABINETS FOR INFLAMMABLE AND RADIOACTIVE PRODUCTS

• Standard EN14470-1 / Fire tests	6
• Cabinets TYPE90 for inflammables: Safety first!	7
• Storage cabinets for inflammables Series FIRE MY11 Grey	8-9
• Storage cabinets for inflammables Series FIRE MY11 Yellow	10-11
• Storage cabinets for inflammables Series BIG FIRE MY11 Grey	12-13
• Storage cabinets for inflammables Series BIG FIRE MY11 Yellow	14-15
• Storage cabinets for inflammables Series BACMY11 Grey	16-17
• Storage cabinets for inflammables Series BACMY11 Yellow	18-19
• Storage cabinets for inflammable and radioactive products Series FIRE RADIO MY11	20-21
• Safety Fire Case	22-23
• Liquid collection system: Waste storage tank	24-25
• Fireproof cabinet accessories	26-27

STORAGE CABINETS FOR GAS CYLINDERS

• Standard EN14470-2	28-29
• Cabinets for the internal storage of gas cylinders - Series BOMB	30-31
• Cabinets for the internal and external storage of gas cylinders - Series BBASIC	32-33
• Certificated box for the external storage of gas cylinders - Series PANDESA®	34
• Box for the external storage of gas cylinders	35

CERTIFIED CABINETS SERIES COMBISTORAGE

• Combined underbench storage cabinets series COMBISTORAGE	36-43
• Combined storage cabinets with 2 compartments Series COMBISTORAGE 2C	44-45
• Combined storage cabinets with 3/4 compartments Series COMBISTORAGE 3C/4C	46-47
• Combined storage cabinets Series COMBISTORAGE 120 FIRE 90	48-49
• Combined storage cabinets Series COMBISTORAGE 60 FIRE 90	50-51
• FIREMY11 and COMBISTORAGE Technical Drawings	52-53

STORAGE CABINETS FOR CHEMICALS AND CORROSIVE SUBSTANCES

• Certified Series CHEMICALS with fan and filter included - Plain and glazed doors	54-55
• Certified Series CHEMICALS BASIC - Plain and glazed doors	56-57
• Certified Series High density PVC - Plain doors	58-59
• Certified Series WOODLINE with fan and filter included - Plain doors	60-61
• Certified Series WOODLINE BASIC - Plain doors	62-63
• Certified Series CS - Plain doors	64-65
• Certified Series CS - Glazed doors	66-67
• Series MULTIRISK - Plain doors	68-69
• Series MULTIRISK - Glazed doors	70-71
• Box for POISON storage	72
• Safety cabinets for hazardous products Series E-LINE	73
• Safety cabinets for storing cytotoxic products	74-75

CHEMISAFE reserves the right to make technical changes to the instruments without notice, according to the evolution of technologies and standards. Non-contractual pictures.

FILTERING VENTILATED CABINETS AND HOODS

• Standard NFX15-211 and operating principle of a fume hood	76-77
• Series CFCS - Fixed shelves - Glass doors	78-79
• Series CFCS - Sliding shelves - Glass doors	80-81
• CHEMIHOOD PLUS	82-83

HOODS

• CHEMIHOOD	84-85
-------------	-------

SERIES PHYTO

• Storage of phytosanitary products	86-87
• Storage cabinets for pest control products and other agricultural products	88-89

VENTILATION

• Ventilation choice guide. The importance of filter replacement	90-91
• Ventilation units with external connection	92-93
• Fresh air box with filtration certified according to standard NFX15-211	94-95
• @CHEMISAFE, @CFN and @DIAM125BPMY11: NEW SMART ASPIRATION SYSTEMS	96-97

SAFETY SHELVING

• Safety shelving made of modular epoxy steel	98
• Safety shelving non modular Stainless steel	99

PRACTICAL INFORMATION

• General conditions of sale	100-101
• Delivery and installation sheet	102

STORAGE CABINETS
FOR INFLAMMABLE AND
RADIOACTIVE PRODUCTS

STORAGE CABINETS
FOR GAS CYLINDERS

CERTIFIED
COMBUSTION
CABINETS SERIES

STORAGE CABINETS
FOR CHEMICALS AND
CORROSIVE SUBSTANCES

FILTERING
VENTILATED CABINETS
AND HOODS

HOODS

SERIES PHYTO

VENTILATION

EQUIPMENTS

Standard EN14470-1



The European standard EN 14470-1 refers to cabinets freely positioned and to wall-mounted cabinets for the storage of inflammables.

All CHEMISAFE cabinet models have undergone a destructive test in a fire room performed in an independent accredited laboratory.

➔ STANDARD DESCRIPTION

➔ FIRE TEST

The wall of the cabinet must be positioned in the fire room at a distance of 100 mm from the wall. The fire resistance of the cabinet must be validated by the destructive test of an identical model. Possible reductions in the dimensions of the cabinet tested:

- Height and width max. 100 mm
- Depth max. 150 mm

The temperature increase inside the cabinet should not exceed 180 K or 200 °C. According to the time taken to reach this temperature, the cabinet will be classified as Type 15, 30, 60 or 90 min.

These different flammability classes allow leaving sufficient time for the staff to leave the laboratory and for the firefighters to get in before the stored flammable products may cause fire.

Each CHEMISAFE cabinet model has passed the compliance control according to standard EN14470-1 and it has the certificates of tests carried out by Bureau Veritas (BV).

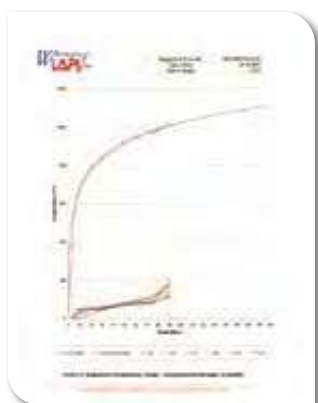

Report of fire resistance test with Temperature/Time diagram. Contact thermocouple increase.

➔ CONSTRUCTION

The cabinet doors must close automatically in case of fire.

The side and rear walls must have the same construction and the same thickness.

On the other hand, the requirements of the standard cover the cabinet construction itself and its capacity to withstand external fire conditions (fire tests carried out according to ISO 834-1 [1] and EN 1363-1).

The tray volume must contain: at least 110 % of the volume of the largest container stored in the cabinet or 10 % of the total volume stored.



CHEMISAFE cabinet series FIRE MY11 BEFORE fire resistance test.

➔ SIGNALLING

The cabinets must be equipped with suitable signals: standard pictograms complying with ISO 3864 (inflammables), maximum load per shelf, fire resistance of the model (15, 30, 60 or 90 minutes).

➔ QUALITY CONTROL

CHEMISAFE submitted its safety cabinet manufacturing to a continuous and extremely rigorous check by Bureau Veritas.

So twice a year, BV checks the production and verifies the quality and the manufacturing process.



CHEMISAFE cabinet series FIRE MY11 AFTER fire resistance test.

CHEMISAFE will make all the cabinet documents and certifications available.

Storage cabinets for inflammables



**FIRE-RESISTANT
CERTIFIED**
90 minutes (TYPE 90)



➤ MAXIMUM PROTECTION FOR SAFETY FIRST!

For obvious safety reasons (fire, corrosion, intoxication...), all the high or low flammables must be handled and stored in fireproof cabinets (fire resistance of 90 minutes) certified according to standard EN14470-1.

We opted for the maximum safety by offering a complete range of fire-resistant cabinets TYPE 90 minutes.

The cabinet construction, the automatic closing of the doors (present on all our models), the thermo-expanding seals and the fire dampers ensure the cabinet containment for 90 minutes and a maximum protection of the people.

➤ WHAT DOES IT MEAN FOR THE USER

- A use according to the regulations
- A maximum use safety
- A certification documentation identifying the safety cabinet (traceability)

Series FIRE MY11 Grey

Certified according to EN14470-1 standard Type 90 & EN16121

FIRE-RESISTANT
CERTIFIED
90 minutes (TYPE 90)



CSF232BMY11



CSF239BMY11



CSF239FMY11

Easy replacement of spare parts
in case of damage



Door closer PS50MY11



Alarm system
AT100



Fire-extinguisher
ESTINTORE

→ TECHNICAL FEATURES:

- Completely made of an electrogalvanized steel plate with a thickness of 1 - 1.5 mm, cold bent - Grey RAL7035
- External finishing made of acidproof epoxy resin and passage through a thermal tunnel a 200 °C
- Cabinet isolation through some high density rock wool panels and some calcium sulphate panels
- Internal finishing with melamine panels highly resistant to chemical and aggressive vapours
- Structure allowing replacing spare parts if necessary
- Automatic door closing when the ambient temperature exceeds 50 °C
- 30 mm thermo-expanding isolation seals which in case of temperature rise ensure a perfect cabinet sealing according to standard EN14470-1
- Air inlet and outlet with certified fire dampers closing ducts when the temperature exceeds 70 °C according to standard 4102-6
- Prearrangement for ventilation through a Ø 100 mm flange for an external connection or a filtering ventilation system (see the chapter on ventilation)

- **Closing and locking system of the doors allowing keeping the doors open** and closing them automatically in case of ambient temperature higher than 50 °C
- Spark resistant hinge ensuring a perfect door solidity
- Cabinet equipped with earthing
- Leveling jacks
- Door key lock
- 3 shelves made of **painted (BASIC series)** or of **stainless steel (EASY series)** whose height can be adjusted, 1 tray with grid
- Shelf fastening on aluminium eyelets excluding all risks of spark
- Fire tested shelves
- ISO 3864: Pictogram signalling
- Certified as fire-resistant for **90 minutes**, according to standard **EN14470-1 BV (Bureau Veritas)**
- Certified according to standard **EN16121 BV (Bureau Veritas)**

→ SERIES FIRE MY11

CODE	DESCRIPTION	EXTERNAL DIMENSIONS (WxDxH) mm	INTERNAL DIMENSIONS (WxDxH) mm	INTERNAL EQUIPMENT	STORAGE CAPACITY*	Weight (Kg)
CSF239BMY11**	Cabinet series FIRE MY11 BASIC with 1 door	595x600x1950	496x446x1540	3 shelves made of painted steel (max. load 60 Kg evenly distributed) + 1 retention tray with grid (capacity 20 Litres)	80 / 100	206
CSF239MY11**	Cabinet series FIRE MY11 EASY with 1 door	595x600x1950	496x446x1540	3 shelves made of stainless steel (max. load 60 Kg evenly distributed) + 1 retention tray with grid (capacity 20 Litres)	80 / 100	206
CSF232BMY11	Cabinet series FIRE MY11 BASIC with 2 doors	1200x600x1950	1095x446x1540	3 shelves made of painted steel (max. load 80 Kg evenly distributed) + 1 retention tray with grid (capacity 45 Litres)	160 / 200	346
CSF232MY11	Cabinet series FIRE MY11 EASY with 2 doors	1200x600x1950	1095x446x1540	3 shelves made of stainless steel (max. load 80 Kg evenly distributed) + 1 retention tray with grid (capacity 45 Litres)	160 / 200	346
CSF239FMY11	Cabinet series FIRE MY11 PHARMACY BASIC with 1 door	595x600x1950	496x446x1540	3 sliding tray shelves made of painted steel (max. load 60 Kg evenly distributed) + 1 sliding retention tray with grid (capacity 20 Litres)	80 / 100	206

*Approximate capacity in bottles holding 1 litre per cabinet

**Left door opening. Add «D» to the item code for the right door opening

→ INTERNAL EQUIPMENT (optional)

CODE	DESCRIPTION	DIMENSIONS (WxDxH) mm	RETENTION VOLUME (LITRES)	STORAGE CAPACITY*
RIP60VMY11	Additional shelf made of painted steel for cabinet with 1 door W600	493x420x39	7	20 / 25
RIP120VMY11	Additional shelf made of painted steel for cabinet with 2 doors	1094x420x39	16	44 / 55
RIP60MY11	Additional shelf made of stainless steel for cabinet with 1 door W600	493x420x39	7	20 / 25
RIP120MY11	Additional shelf made of stainless steel for cabinet with 2 doors	1094x420x39	16	44 / 55
S60S	Frame for pull-out shelf for fire 60 (shelf not included)			
RIP60VS	Additional sliding shelf made of painted steel for S60S	394x420x39	7	20 / 25
RIP60IS	Additional sliding shelf made of stainless steel for S60S	394x420x39	7	20 / 25
S120S	Frame for pull-out shelf for fire 120 (shelf not included)			
RIP120VS	Additional sliding shelf made of painted steel for S120S	925 x420x39	16	44 / 55
RIP120IS	Additional sliding shelf made of stainless steel for S120S	925 x420x39	16	44 / 55
RIPGI	Additional rotating shelf for cabinet with 1 door			
PS50SMY11	Replacement system with closing thermal fuse - left door	-	-	-
PS50MY11	Replacement system with closing thermal fuse - right door	-	-	-
ZOCPAL60MY11	Pallet truck base plate W600	595x600x110	-	-
ZOCPAL120MY11	Pallet truck base plate W1200	1200x600x110	-	-
CHEMIROLL	Wheel board to move the cabinets (the code ZOCPALMY11 is necessary)	-	-	-
CSFR127	Internal cooling system of the storage cabinet for products with a low flammability degree for high cabinet with 1 door W600	-	-	-
CSFR128	Internal cooling system of the storage cabinet for products with a low flammability degree for high cabinet 2 doors	-	-	-
AT100	Visual and audible alarm system with telephone transmission equipped with a digital thermostat with a T probe (°C) inside the cabinet			
TIM24	Daily counter	-	-	-
ESTINTORE	Internal carbon dioxide fire-extinguisher with automatic thermal tripping (62 °C)	Ø 90x280	-	-

*Approximate capacity in bottles holding 1 litre

→ VENTILATION (optional)*

CODE	DESCRIPTION	DIMENSIONS (WxDxH) mm
DIAM125BP	Fresh air box with filter holding box for high cabinet with 1 or 2 doors - outlet Ø: 125 mm (filter excluded)	290x290x270
CSF100BPAMY11	Fresh air box ATEX with power cable and filter box - outlet diam. 125 mm	350x370x500
RSOL	Activated charcoal filter for organic solvents - series FIRE MY11 (to replace at least 3 times a year)	235x110x15
GFKIT100	External connection kit (1 metre of hose diam. 100 mm and 2 clamps)	Ø 100 - W 1000 mm
CFN	Fresh air box with molecular filtration according to standard NFX15-211, with visual and audible alarm	550x500x220
CFNL	Molecular filtration box manufactured, without alarm	550x500x220
CFNCO	Hour counter for CFN	
CSAS	Activated charcoal filter for solvents (prefilter included)	510x405x60
CSBE	Activated charcoal filter for acids (prefilter included)	510x405x60
CSMP	Activated charcoal filter for solvents and acids (prefilter included)	510x405x60
CSPF	Prefilter	510x405x15
CSPFO	ACTIVATED carbon filter for FORMALINE (for CFN)	

*To obtain the complete list of the connection accessories, see the chapter on ventilation of this catalogue and the current price list

Series FIRE MY11 Yellow

Certified according to EN14470-1
standard Type 90 & EN16121

**FIRE-RESISTANT
CERTIFIED**
90 minutes (TYPE 90)



CSF232BMY11Y



CSF239BMY11Y



Painted steel shelf
RIP60VMY11



Stainless steel shelf
RIP60XMY11

High storage capacity

→ TECHNICAL FEATURES:

- Completely made of an electrogalvanized steel plate with a thickness of 1 - 1.5 mm, cold bent - Yellow RAL1021
- External finishing in acidproof epoxy resin and passage through a thermal tunnel at 200 °C
- Cabinet isolation through some high density rock wool panels and some calcium sulphate panels
- Internal finishing with melamine panels highly resistant to chemical and aggressive vapours
- Structure allowing replacing spare parts if necessary
- Automatic door closing when the ambient temperature exceeds 50 °C
- 30 mm thermo-expanding isolation seals which in case of temperature rise ensure a perfect cabinet sealing according to standard EN14470-1
- Air inlet and outlet with certified fire dampers closing ducts when the temperature exceeds 70 °C according to standard DIN 4102-6
- Prearrangement for ventilation through a Ø 100 mm flange for an external connection or a filtering ventilation system (see the chapter on ventilation)
- **Closing and locking system of the doors allowing keeping the doors open** and closing them automatically in case of ambient temperature higher than 50 °C
- Spark resistant hinge ensuring a perfect door solidity
- Cabinet equipped with earthing
- Leveling jacks
- Door key lock
- 3 shelves made of painted steel (**BASIC series**) or of stainless steel (**EASY series**) whose height can be adjusted, 1 retention tray with grid
- Shelf fastening on aluminium eyelets excluding all risks of spark
- Fire tested shelves
- ISO 3864 : Pictogram signalling
- Certified as fire-resistant for **90 minutes**, according to standard **EN14470-1 BV (Bureau Veritas)**
- Certified according to standard **EN16121 BV (Bureau Veritas)**

→ SERIES FIRE MY11

CODE	DESCRIPTION	EXTERNAL DIMENSIONS (WxDxH) mm	INTERNAL DIMENSIONS (WxDxH) mm	INTERNAL EQUIPMENT	STORAGE CAPACITY*	Weight (Kg)
CSF239BMY11Y**	Yellow cabinet series FIRE MY11 BASIC with 1 door	595x600x1950	496x446x1540	3 shelves made of painted steel (max. load 60 Kg evenly distributed) + 1 retention tray with grid (capacity 20 Litres)	80 / 100	206
CSF239MY11Y**	Yellow cabinet series FIRE MY11 EASY with 1 door	595x600x1950	496x446x1540	3 shelves made of stainless steel (max. load 60 Kg evenly distributed) + 1 retention tray with grid (capacity 20 Litres)	80 / 100	206
CSF232BMY11Y	Yellow cabinet series FIRE MY11 BASIC with 2 doors	1200x600x1950	1095x446x1540	3 shelves made of painted steel (max. load 80 Kg evenly distributed) + 1 retention tray with grid (capacity 45 Litres)	160 / 200	346
CSF232MY11Y	Yellow cabinet series FIRE MY11 EASY with 2 doors	1200x600x1950	1095x446x1540	3 shelves made of stainless steel (max. load 80 Kg evenly distributed) + 1 retention tray with grid (capacity 45 Litres)	160 / 200	346

*Approximate capacity in bottles holding 1 litre per cabinet

**Left door opening. Add «D» to the item code for the right door opening

→ INTERNAL EQUIPMENT (optional)

CODE	DESCRIPTION	DIMENSIONS (WxDxH) mm	RETENTION VOLUME (LITRES)	STORAGE CAPACITY*
RIP60VMY11	Additional shelf made of painted steel for cabinet with 1 door W600	493x420x39	7	20 / 25
RIP120VMY11	Additional shelf made of painted steel for cabinet with 2 doors	1094x420x39	16	44 / 55
RIP60MY11	Additional shelf made of stainless steel for cabinet with 1 door W600	493x420x39	7	20 / 25
RIP120MY11	Additional shelf made of stainless steel for cabinet with 2 doors	1094x420x39	16	44 / 55
S60S	Frame for pull-out shelf for fire 60 (shelf not included)			
RIP60VS	Additional sliding shelf made of painted steel for S60S	394x420x39	7	20 / 25
RIP60IS	Additional sliding shelf made of stainless steel for S60S	394x420x39	7	20 / 25
S120S	Frame for pull-out shelf for fire 120 (shelf not included)			
RIP120VS	Additional sliding shelf made of painted steel for S120S	925 x420x39	16	44 / 55
RIP120IS	Additional sliding shelf made of stainless steel for S120S	925 x420x39	16	44 / 55
RIPGI	Additional rotating shelf for cabinet with 1 door			
PS50SMY11	Replacement system with closing thermal fuse - left door	-	-	-
PS50MY11	Replacement system with closing thermal fuse - right door	-	-	-
ZOCPAL60MY11	Pallet truck base plate W600	595x600x110	-	-
ZOCPAL120MY11	Pallet truck base plate W1200	1200x600x110	-	-
CHEMIROLL	Wheel board to move the cabinets (the code ZOCPALMY11 is necessary)	-	-	-
CSFR127	Internal cooling system of the storage cabinet for products with a low flammability degree for high cabinet with 1 door W600	-	-	-
CSFR128	Internal cooling system of the storage cabinet for products with a low flammability degree for high cabinet 2 doors	-	-	-
AT100	Visual and audible alarm system with telephone transmission equipped with a digital thermostat with a T probe (°C) inside the cabinet			
TIM24	Daily counter	-	-	-
ESTINTORE	Internal carbon dioxide fire-extinguisher with automatic thermal tripping (62 °C)	Ø 90x280	-	-

*Approximate capacity in bottles holding 1 litre

→ VENTILATION (optional)*

CODE	DESCRIPTION	DIMENSIONS (WxDxH) mm
DIAM125BP	Fresh air box with filter holding box for high cabinet with 1 or 2 doors - outlet Ø: 125 mm (filter excluded)	290x290x270
CSF100BPAMY11	Fresh air box ATEX with power cable and filter box - outlet diam. 125 mm	350x370x500
RSOL	Activated charcoal filter for organic solvents - series FIRE MY11 (to replace at least 3 times a year)	235x110x15
GFKIT100	External connection kit (1 metre of hose diam. 100 mm and 2 clamps)	Ø 100 - W 1000 mm
CFN	Fresh air box with molecular filtration according to standard NFX15-211, with visual and audible alarm	550x500x220
CFNL	Molecular filtration box manufactured, without alarm	550x500x220
CFNCO	Hour counter for CFN	
CSAS	Activated charcoal filter for solvents (prefilter included)	510x405x60
CSBE	Activated charcoal filter for acids (prefilter included)	510x405x60
CSMP	Activated charcoal filter for solvents and acids (prefilter included)	510x405x60
CSPF	Prefilter	510x405x15
CSPFO	ACTIVATED carbon filter for FORMALINE (for CFN)	

*To obtain the complete list of the connection accessories, see the chapter on ventilation of this catalogue and the current price list

Series **BIG FIRE MY11** Grey

Certified according to EN14470-1 standard Type 90 & EN16121

**FIRE-RESISTANT
CERTIFIED**
90 minutes (TYPE 90)



CSF240BMY11



CSF240BMY11 OPEN

THE NEW WAY

More storage, less expensive, same security

STORAGE CAPACITY: 128/160 1 liter bottle
+ 60% bigger than one-door cabinet
- 28% less than a two-door

→ TECHNICAL FEATURES:

- Completely made of an electrogalvanized steel plate with a thickness of 1 - 1.5 mm, cold bent - Grey RAL7035
- External finishing made of acidproof epoxy resin and passage through a thermal tunnel a 200 °C
- Cabinet isolation through some high density rock wool panels and some calcium sulphate panels
- Internal finishing with melamine panels highly resistant to chemical and aggressive vapours
- Structure allowing replacing spare parts if necessary
- Automatic door closing when the ambient temperature exceeds 50 °C
- 30 mm thermo-expanding isolation seals which in case of temperature rise ensure a perfect cabinet sealing according to standard EN14470-1
- Air inlet and outlet with certified fire dampers closing ducts when the temperature exceeds 70 °C according to standard 4102-6
- Prearrangement for ventilation through a Ø 100 mm flange for an external connection or a filtering ventilation system (see the chapter on ventilation)
- **Closing and locking system of the doors allowing keeping the doors open** and closing them automatically in case of ambient temperature higher than 50 °C
- Spark resistant hinge ensuring a perfect door solidity
- Cabinet equipped with earthing
- Leveling jacks
- Door key lock
- 3 shelves made of **painted (BASIC series)** or of **stainless steel (EASY series)** whose height can be adjusted, 1 bottom sump with draining grid which allows a bigger storage volume
- Shelf fastening on aluminium eyelets excluding all risks of spark
- Fire tested shelves
- ISO 3864: Pictogram signalling
- Certified as fire-resistant for **90 minutes**, according to standard **EN14470-1 BV (Bureau Veritas)**
- Certified according to standard **EN16121 BV (Bureau Veritas)**

→ SERIES BIG FIRE MY11

CODE	DESCRIPTION	EXTERNAL DIMENSIONS (WxDxH) mm	INTERNAL DIMENSIONS (WxDxH) mm	INTERNAL EQUIPMENT	STORAGE CAPACITY*	Weight (Kg)
CSF240BMY11**	Cabinet series BIG FIRE MY11 BASIC with 1 door - W900	895x600x1950	796x446x1540	3 shelves made of painted steel (max. load 70 Kg evenly distributed) + 1 retention tray with grid (capacity 25 Litres)	128 / 160	275
CSF240MY11**	Cabinet series BIG FIRE MY11 EASY with 1 door - W900	895x600x1950	796x446x1540	3 shelves made of stainless steel (max. load 70 Kg evenly distributed) + 1 retention tray with grid (capacity 25 Litres)	128 / 160	275

*Approximate capacity in bottles holding 1 litre per cabinet

**Left door opening. Add «D» to the item code for the right door opening

→ INTERNAL EQUIPMENT (optional)

CODE	DESCRIPTION	DIMENSIONS (WxDxH) mm	RETENTION VOLUME (LITRES)	STORAGE CAPACITY*
RIP90VMY11	Additional shelf made of painted steel for cabinet with 1 door W900	793x420x39	12	32 / 40
RIP90MY11	Additional shelf made of stainless steel for cabinet with 1 door W900	793x420x39	12	32 / 40
S90S	Frame for pull-out shelf for FIRE 90 (shelf not included)			
RIP90VS	Additional sliding shelf made of painted steel for S90S	695x420x39	12	32 / 40
RIP90IS	Additional sliding shelf made of stainless steel for S90S	695x420x39	12	32 / 40
PS50SMY11	Replacement system with closing thermal fuse - left door	-	-	-
PS50MY11	Replacement system with closing thermal fuse - right door	-	-	-
ZOCPAL90MY11	Pallet truck base plate W900	895x600x110	-	-
CHEMIROLL	Wheel board to move the cabinets (the code ZOCPALMY11 is necessary)	-	-	-
CSFR129	Internal cooling system of the storage cabinet for products with a low flammability degree for high cabinet with 1 door W900	-	-	-
AT100	Visual and audible alarm system with telephone transmission equipped with a digital thermostat with a T probe (°C) inside the cabinet			
TIM24	Daily counter	-	-	-
ESTINTORE	Internal carbon dioxide fire-extinguisher with automatic thermal tripping (62 °C)	Ø 90x280	-	-

*Approximate capacity in bottles holding 1 litre

→ VENTILATION (optional)*

CODE	DESCRIPTION	DIMENSIONS (WxDxH) mm
DIAM125BP	Fresh air box with filter holding box for high cabinet with 1 or 2 doors - outlet Ø: 125 mm (filter excluded)	290x290x270
CSF100BPAMY11	Fresh air box ATEX with power cable and filter box - outlet diam. 125 mm	350x370x500
RSOL	Activated charcoal filter for organic solvents - series FIRE MY11 (to replace at least 3 times a year)	235x110x15
GFKIT100	External connection kit (1 metre of hose diam. 100 mm and 2 clamps)	Ø 100 - W 1000 mm
CFN	Fresh air box with molecular filtration according to standard NFX15-211, with visual and audible alarm	550x500x220
CFNL	Molecular filtration box manufactured, without alarm	550x500x220
CFNCO	Hour counter for CFN	
CSAS	Activated charcoal filter for solvents (prefilter included)	510x405x60
CSBE	Activated charcoal filter for acids (prefilter included)	510x405x60
CSMP	Activated charcoal filter for solvents and acids (prefilter included)	510x405x60
CSPF	Prefilter	510x405x15
CSPFO	ACTIVATED carbon filter for FORMALINE (for CFN)	

*To obtain the complete list of the connection accessories, see the chapter on ventilation of this catalogue and the current price list



Series **BIG FIRE MY11** Yellow

Certified according to EN14470-1 standard Type 90 & EN16121

**FIRE-RESISTANT
CERTIFIED**
90 minutes (TYPE 90)



CSF240BMY11Y



CSF240BMY11Y OPEN

THE NEW WAY
More storage, less expensive, same security

128/160 1 liter bottle
+ 60% bigger than one-door cabinet
- 28% less than a two-door

→ TECHNICAL FEATURES:

- Completely made of an electrogalvanized steel plate with a thickness of 1 - 1.5 mm, cold bent - Grey RAL7035
- External finishing made of acidproof epoxy resin and passage through a thermal tunnel a 200 °C
- Cabinet isolation through some high density rock wool panels and some calcium sulphate panels
- Internal finishing with melamine panels highly resistant to chemical and aggressive vapours
- Structure allowing replacing spare parts if necessary
- Automatic door closing when the ambient temperature exceeds 50 °C
- 30 mm thermo-expanding isolation seals which in case of temperature rise ensure a perfect cabinet sealing according to standard EN14470-1
- Air inlet and outlet with certified fire dampers closing ducts when the temperature exceeds 70 °C according to standard 4102-6
- Prearrangement for ventilation through a Ø 100 mm flange for an external connection or a filtering ventilation system (see the chapter on ventilation)
- Closing and locking system of the doors allowing keeping the doors open and closing them automatically in case of ambient temperature higher than 50 °C
- Spark resistant hinge ensuring a perfect door solidity
- Cabinet equipped with earthing
- Leveling jacks
- Door key lock
- 3 shelves made of painted (BASIC series) or of stainless steel (EASY series) whose height can be adjusted, 1 bottom sump with draining grid which allows a bigger storage volume
- Shelf fastening on aluminium eyelets excluding all risks of spark
- Fire tested shelves
- ISO 3864: Pictogram signalling
- Certified as fire-resistant for 90 minutes, according to standard EN14470-1 BV (Bureau Veritas)
- Certified according to standard EN16121 BV (Bureau Veritas)

→ SERIES BIG FIRE MY11

CODE	DESCRIPTION	EXTERNAL DIMENSIONS (WxDxH) mm	INTERNAL DIMENSIONS (WxDxH) mm	INTERNAL EQUIPMENT	STORAGE CAPACITY*	Weight (Kg)
CSF240BMY11Y**	Yellow cabinet series BIG FIRE MY11 BASIC with 1 door - W900	895x600x1950	796x446x1540	3 shelves made of painted steel (max. load 70 Kg evenly distributed) + 1 retention tray with grid (capacity 25 Litres)	128 / 160	275
CSF240MY11Y**	Yellow cabinet series BIG FIRE MY11 EASY with 1 door - W900	895x600x1950	796x446x1540	3 shelves made of stainless steel (max. load 70 Kg evenly distributed) + 1 retention tray with grid (capacity 25 Litres)	128 / 160	275

*Approximate capacity in bottles holding 1 litre per cabinet

**Left door opening. Add «D» to the item code for the right door opening

→ INTERNAL EQUIPMENT (optional)

CODE	DESCRIPTION	DIMENSIONS (WxDxH) mm	RETENTION VOLUME (LITRES)	STORAGE CAPACITY*
RIP90VMY11	Additional shelf made of painted steel for cabinet with 1 door W900	793x420x39	12	32 / 40
RIP90MY11	Additional shelf made of stainless steel for cabinet with 1 door W900	793x420x39	12	32 / 40
S90S	Frame for pull-out shelf for FIRE 90 (shelf not included)			
RIP90VS	Additional sliding shelf made of painted steel for S90S	695x420x39	12	32 / 40
RIP90IS	Additional sliding shelf made of stainless steel for S90S	695x420x39	12	32 / 40
PS50SMY11	Replacement system with closing thermal fuse - left door	-	-	-
PS50MY11	Replacement system with closing thermal fuse - right door	-	-	-
ZOCPAL90MY11	Pallet truck base plate W900	895x600x110	-	-
CHEMIROLL	Wheel board to move the cabinets (the code ZOCPALMY11 is necessary)	-	-	-
CSFR129	Internal cooling system of the storage cabinet for products with a low flammability degree for high cabinet with 1 door W900	-	-	-
AT100	Visual and audible alarm system with telephone transmission equipped with a digital thermostat with a T probe (°C) inside the cabinet			
TIM24	Daily counter	-	-	-
ESTINTORE	Internal carbon dioxide fire-extinguisher with automatic thermal tripping (62 °C)	Ø 90x280	-	-

*Approximate capacity in bottles holding 1 litre

→ VENTILATION (optional)*

CODE	DESCRIPTION	DIMENSIONS (WxDxH) mm
DIAM125BP	Fresh air box with filter holding box for high cabinet with 1 or 2 doors - outlet Ø: 125 mm (filter excluded)	290x290x270
CSF100BPAMY11	Fresh air box ATEX with power cable and filter box - outlet diam. 125 mm	350x370x500
RSOL	Activated charcoal filter for organic solvents - series FIRE MY11 (to replace at least 3 times a year)	235x110x15
GFKIT100	External connection kit (1 metre of hose diam. 100 mm and 2 clamps)	Ø 100 - W 1000 mm
CFN	Fresh air box with molecular filtration according to standard NFX15-211, with visual and audible alarm	550x500x220
CFNL	Molecular filtration box manufactured, without alarm	550x500x220
CFNCO	Hour counter for CFN	
CSAS	Activated charcoal filter for solvents (prefilter included)	510x405x60
CSBE	Activated charcoal filter for acids (prefilter included)	510x405x60
CSMP	Activated charcoal filter for solvents and acids (prefilter included)	510x405x60
CSPF	Prefilter	510x405x15
CSPFO	ACTIVATED carbon filter for FORMALINE (for CFN)	

*To obtain the complete list of the connection accessories, see the chapter on ventilation of this catalogue and the current price list



Series BACMY11 Grey

Certified according to EN14470-1 standard Type 90 & EN16121

**FIRE-RESISTANT
CERTIFIED**
90 minutes (TYPE 90)



CSF232BACMY11



CSF239BACMY11



Alarm system AT100



Painted steel shelf
RIP60VMY11



Closing system

Closing system allowing keeping the doors open

→ TECHNICAL FEATURES:

- Completely made of an electrogalvanized steel plate with a thickness of 1 - 1,5 mm, cold bent - Grey RAL7035
- External finishing in acidproof epoxy resin and passage through a thermal tunnel at 200 °C
- Cabinet isolation through some high density rock wool panels and some calcium sulphate panels
- Internal finishing with melamine panels highly resistant to chemical and aggressive vapours
- Structure allowing replacing spare parts if necessary
- Automatic door closing when the ambient temperature exceeds 50 °C
- 30 mm thermo-expanding isolation seals which in case of temperature rise ensure a perfect cabinet sealing according to standard EN14470-1
- Air inlet and outlet with certified fire dampers closing ducts when the temperature exceeds 70 °C according to standard DIN 4102-6.
- Prearrangement for ventilation through a Ø 100 mm flange for an external connection or a filtering ventilation system (see the chapter on ventilation)
- Closing and locking system of the doors allowing keeping the doors opened and closing them automatically in case of ambient temperature higher than 50 °C
- Spark resistant hinge ensuring a perfect door solidity
- Cabinet equipped with earthing
- Leveling jacks
- Door key lock
- 3 shelves made of painted or stainless steel (optional) whose height can be adjusted, 1 retention tray with grid
- Shelf fastening on some aluminium eyelets excluding all risks of spark
- Fire tested shelves
- ISO 3864 : Pictogram signalling
- Certified as fire-resistant for **90 minutes**, according to standard **EN14470-1 BV (Bureau Veritas)**
- Certified according to standard **EN16121 BV (Bureau Veritas)**

→ SERIES BACMY11

CODE	DESCRIPTION	EXTERNAL DIMENSIONS (WxDxH) mm	INTERNAL DIMENSIONS (WxDxH) mm	INTERNAL EQUIPMENT	STORAGE CAPACITY*	Weight (Kg)
CSF239BACMY11**	Cabinet series BACMY11 with 1 door	595x600x1950	496x446x1540	3 shelves made of painted steel (max. load 60 Kg evenly distributed) + 1 retention tray with grid (capacity 20 Litres)	80/100	209
CSF232BACMY11	Cabinet series BACMY11 BASIC with 2 doors	1200x600x1950	1095x446x1540	3 shelves made of painted steel (max. load 80 Kg evenly distributed) + 1 retention tray with grating (capacity 45 Litres)	160 / 200	349

*Approximate capacity in bottles holding 1 litre per cabinet

**Left door opening. Add «D» to the item code for the right door opening

→ INTERNAL EQUIPMENT (optional)

CODE	DESCRIPTION	DIMENSIONS (WxDxH) mm	RETENTION VOLUME (LITRES)	STORAGE CAPACITY*
RIP60VMY11	Additional shelf made of painted steel for cabinet with 1 door W600	493x420x39	7	20 / 25
RIP120VMY11	Additional shelf made of painted steel for cabinet with 2 doors	1094x420x39	16	44 / 55
RIP60MY11	Additional shelf made of stainless steel for cabinet with 1 door W600	493x420x39	7	20 / 25
RIP120MY11	Additional shelf made of stainless steel for cabinet with 2 doors	1094x420x39	16	44 / 55
RIPGI	Additional rotating shelf for cabinet with 1 door			
PS50SMY11	Replacement system with closing thermal fuse - left door	-	-	-
PS50MY11	Replacement system with closing thermal fuse - right door	-	-	-
ZOCPAL60MY11	Pallet truck base plate W600	595x600x110	-	-
ZOCPAL120MY11	Pallet truck base plate W1200	1200x600x110	-	-
CHEMIROLL	Wheel board to move the cabinets (the code ZOCPALMY11 is necessary)	-	-	-
CSFR127	Internal cooling system of the storage cabinet for products with a low flammability degree for high cabinet with 1 door W600	-	-	-
CSFR128	Internal cooling system of the storage cabinet for products with a low flammability degree for high cabinet with 2 doors	-	-	-

*Approximate capacity in bottles holding 1 litre

→ VENTILATION (optional)*

CODE	DESCRIPTION	DIMENSIONS (WxDxH) mm
DIAM125BP	Fresh air box holding box for high cabinet with 1 or 2 doors - outlet Ø: 125 mm (filter excluded)	290x290x270
CSF100BPAMY11	Fresh air box ATEX with power cable - outlet diam. 125 mm	350x370x500
RSOL	Activated charcoal filter for organic solvents - series FIRE MY11 (to replace at least 3 times a year)	235x110x15
GFKIT100	External connection kit (1 metre of hose diam. 100 mm and 2 clamps)	Ø 100 - W 1000 mm
CFN	Fresh air box with molecular filtration according to NFX15-211 standard, with visual and audible alarm	550x500x220
CFNL	Molecular filtration box manufactured, without alarm	550x500x220
CFNCO	Hour counter for CFN	
CSAS	Activated charcoal filter for solvents (prefilter included)	510x405x60
CSBE	Activated charcoal filter for acids (prefilter included)	510x405x60
CSMP	Activated charcoal filter for solvents and acids (prefilter included)	510x405x60
CSPF	Prefilter	510x405x15
CSPFO	ACTIVATED carbon filter for FORMALINE (for CFN)	

*To obtain the complete list of the connection accessories, see the chapter on ventilation of this catalogue and the current price list

Series BACMY11 Yellow

Certified according to EN14470-1 standard Type 90 & EN16121



**FIRE-RESISTANT
CERTIFIED**
90 minutes (TYPE 90)



CSF239BACMY11Y



CSF232BACMY11Y



CSF232BACMY11Y



Closing system

Shelf made of painted steel RIP60VMY11



Ideal for industry!

→ TECHNICAL FEATURES:

- Completely made of an electrogalvanized steel plate with a thickness of 1 - 1.5 mm, cold bent - Yellow RAL1021
- External finishing in acidproof epoxy resin and passage through a thermal tunnel at 200 °C
- Cabinet isolation through some high density rock wool panels and some calcium sulphate panels
- Internal finishing with melamine panels highly resistant to chemical and aggressive vapours
- Structure allowing replacing the parts if necessary
- Automatic door closing when the ambient temperature exceeds 50 °C
- 30 mm thermo-expanding isolation seals which in case of temperature rise ensure a perfect cabinet sealing according to standard EN14470-1
- Air inlet and outlet with certified fire dampers closing ducts when the temperature exceeds 70 °C according to standard e DIN 4102-6.
- Prearrangement for ventilation through a Ø 100 mm flange for an external connection or a filtering ventilation system (see the chapter on ventilation)
- Closing and locking system of the doors allowing keeping the doors opened and closing them automatically in case of ambient temperature higher than 50 °C
- Spark resistant hinge ensuring a perfect door solidity
- Cabinet equipped with earthing
- Leveling jacks
- Door key lock
- 3 shelves made of painted or stainless steel (optional) whose height can be adjusted, 1 retention tray with grid
- Shelf fastening on aluminium eyelets excluding all risks of spark
- Fire tested shelves
- ISO 3864: Pictogram signalling
- Certified as fire-resistant for **90 minutes**, according to standard **EN14470-1 BV (Bureau Veritas)**
- Certified according to standard **EN16121 BV (Bureau Veritas)**

→ SERIES BACMY11

CODE	DESCRIPTION	EXTERNAL DIMENSIONS (WxDxH) mm	INTERNAL DIMENSIONS (WxDxH) mm	INTERNAL EQUIPMENT	STORAGE CAPACITY*	Weight (kg)
CSF239BACMY11Y**	Cabinet series BACMY11 with 1 door	595x600x1950	496x446x1540	3 shelves made of paint ed steel (max. load 60 KG evenly distributed) + 1 retention tray with grid (capacity 20 Litres)	80/100	209
CSF232BACMY11Y	Cabinet series BACMY11 BASIC with 2 doors	1200x600x1950	1095x446x1540	3 shelves made of paint ed steel (max. load 80 KG evenly distributed) + 1 retention tray with grid (capacity 45 Litres)	160 / 200	349

*Approximate capacity in bottles holding 1 litre per cabinet

**Left door opening. Add «D» to the item code for the right door opening

→ INTERNAL EQUIPMENT (optional)

CODE	DESCRIPTION	DIMENSIONS (WxDxH) mm	RETENTION VOLUME (LITRES)	STORAGE CAPACITY*
RIP60VMY11	Additional shelf made of paint ed steel for cabinet with 1 door W600	493x420x39	7	20 / 25
RIP120VMY11	Additional shelf made of paint ed steel for cabinet with 2 doors	1094x420x39	16	44 / 55
RIP60MY11	Additional shelf made of stain less steel for cabinet with 1 door W600	493x420x39	7	20 / 25
RIP120MY11	Additional shelf made of stain less steel for cabinet with 2 doors	1094x420x39	16	44 / 55
RIPGI	Additional rotating shelf for cabinet with 1 door			
PS50SMY11	Replacement system with closing thermal fuse - left door	-	-	-
PS50MY11	Replacement system with closing thermal fuse - right door	-	-	-
ZOCPAL60MY11	Pallet truck base plate W600	595x600x110	-	-
ZOCPAL120MY11	Pallet truck base plate W1200	1200x600x110	-	-
CHEMIROLL	Wheel board to move the cabinets (the code ZOCPALMY11 is necessary)	-	-	-
CSFR127	Internal cooling system of the storage cabinet for products with a low flammability degree for high cabinet with 1 door W600	-	-	-
CSFR128	Internal cooling system of the storage cabinet for products with a low flammability degree for high cabinet with 2 doors	-	-	-

*Approximate capacity in bottles holding 1 litre

→ VENTILATION (optional)*

CODE	DESCRIPTION	DIMENSIONS (WxDxH) mm
DIAM125BP	Fresh air box with filter holding box for high cabinet with 1 or 2 doors - outlet Ø: 125 mm (filter excluded)	290x290x270
CSF100BPAMY11	Fresh air box ATEX with power cable and filter box - outlet diam. 125 mm	350x370x500
RSOL	Activated charcoal filter for organic solvents - series FIRE MY11 (to replace at least 3 times a year)	235x110x15
GFKIT100	External connection kit (1 metre of hose diam. 100 mm and 2 clamps)	Ø 100 - W 1000 mm
CFN	Fresh air box with molecular filtration according to standard NFX15-211, with visual and audible alarm	550x500x220
CFNL	Molecular filtration box manufactured, without alarm	550x500x220
CFNCO	Hour counter for CFN	
CSAS	Activated charcoal filter for solvents (prefilter included)	510x405x60
CSBE	Activated charcoal filter for acids (prefilter included)	510x405x60
CSMP	Activated charcoal filter for solvents and acids (prefilter included)	510x405x60
CSPF	Prefilter	510x405x15
CSPFO	ACTIVATED carbon filter for FORMALINE (for CFN)	

*To obtain the complete list of the connection accessories, see the chapter on ventilation of this catalogue and the current price list



Series FIRE RADIO MY11

Certified according to EN14470-1 Type 90



CSF239XMY11



CSF239XMY11 - Open

**FIRE-RESISTANT
CERTIFIED**
90 minutes (TYPE 90)



CSF500X



CSF606XMY11



CSF500X
+ CSF560

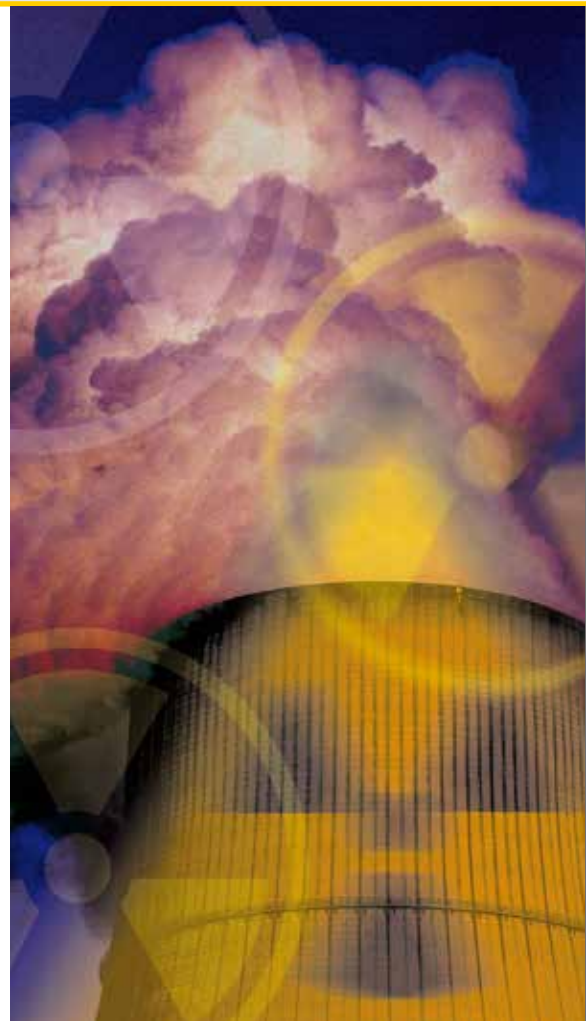

✓
Several thicknesses of lead can be obtained according to the radioactivity of the stored products.
Our design department is at your disposal to carry out your projects.

Completely made of stainless steel with a layer of lead whose thickness can vary from 2 to 5 mm

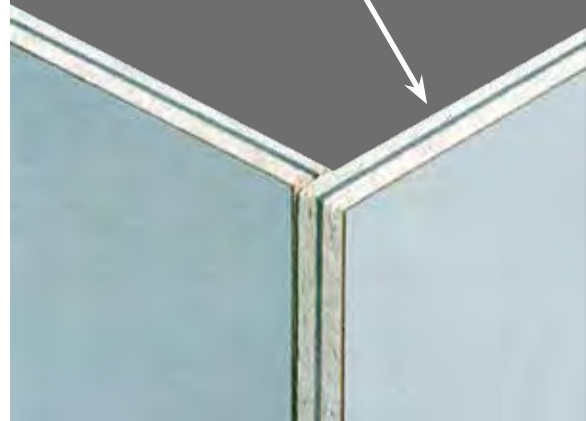

→ TECHNICAL FEATURES:

- Completely made of electrogalvanized stainless steel AISI304 with a thickness from 1 to 1.5 mm, cold bent
- Cabinet isolation through some high density rock wool panels and some calcium sulphate panels
- Internal finishing with melamine and lead panels whose **thickness varies from 2 and 5 mm** according to the level of radioactivity of the stored products (please contact us)
- Structure allowing replacing spare parts if necessary
- Automatic door closing when the ambient temperature exceeds 50 °C
- 30 mm thermo-expanding isolation seals that in case of temperature rise ensure a perfect cabinet sealing, according to standard EN14470-1
- Air inlet and outlet with certified fire dampers closing ducts when the temperature is higher than 70 °C according to standard DIN 4102-6
- Prearrangement for ventilation through a Ø 100 mm flange for an external connection or a filtering ventilation system (see the chapter on ventilation)
- Door closing and locking system allowing keeping the doors open and closing them automatically in case of ambient temperature higher than 50 °C
- Spark resistant hinge ensuring a perfect door solidity
- Cabinet equipped with earthing
- Leveling jacks
- Door key lock
- 3 stainless steel shelves whose height can be adjusted, 1 retention tray with grid (high model with 1 door)
- Shelf fastening on steel eyelets excluding all risks of sparks
- Shelves tested to fire
- ISO 3864: Pictogram signalling
- Certified as fire-resistant for **90 minutes** (30 minutes for the Safety Fire Case model), according to standard **EN14470-1 BV (Bureau Veritas)**

→ SERIES FIRE RADIO MY11

CODE	DESCRIPTION	EXTERNAL DIMENSIONS (WxDxH) mm	INTERNAL DIMENSIONS (WxDxH) mm	INTERNAL EQUIPMENT	STORAGE CAPACITY*	Weight (Kg)
CSF239XMY11	Cabinet series FIRE RADIO MY11 with 1 door	595x600x1950	490x440x1540	3 stainless steel shelves (max load 60 Kg evenly distributed) + 1 retention tray with stainless steel grid (capacity 20 Litres)	60 / 80	350
CSF606XMY11	Underbench cabinet series FIRE RADIO MY11 with 1 door	595x600x620+80	490x440x510	1 retention tray with stainless steel grid (capacity 20 Litres)	15 / 20	150
CSF500X	Safety Fire Case RADIO	340x340x400	200x200x265	1 stainless steel retention tray	4	45

*Approximate capacity in bottles holding 1 litre per cabinet

→ INTERNAL EQUIPEMENT (optional)

CODE	DESCRIPTION	DIMENSIONS (WxDxH) mm	RETENTION VOLUME (LITRES)	STORAGE CAPACITY*
RADIORIP60MY11	Additional stainless steel shelf for cabinet radio with 1 door	490x420x39	7	15/20
RADIOUBRIP60MY11	Additional stainless steel shelf for underbench cabinet radio with 1 door	458x300x39	5	15/20
ESTINTORE	External carbon dioxide fire-extinguisher with automatic thermal tripping (62 °C)	Ø 90x280	-	-
CSF560	Wheeled carriage to transport the Safety Fire Case	-	-	-

*Approximate capacity in bottles holding 1 litre

→ VENTILATION (optional)*

CODE	DESCRIPTION	DIMENSIONS (WxDxH) mm
DIAM125BP	Fresh air box with filter holding box for high cabinet with 1 or 2 doors - outlet Ø: 125 mm (filter excluded)	290x290x270
CSF100BPAMY11	Fresh air box ATEX with power cable and filter box - outlet diameter 125 mm	350x370x500
RSOL	Activated charcoal filter for organic solvents (to replace at least twice a year)	235x110x15
GFKIT100	External connection kit (1 metre of hose diam. 100 mm and 2 pipe clamps)	Ø 100 - W 1000 mm

*To obtain the complete list of the connection accessories, see the chapter on ventilation of this catalogue and the current price list

SAFETY FIRE CASE

Certified according to EN14470-1 Type 30

Portable safety box to store 4 bottles (1L)
of inflammable liquids

**FIRE-RESISTANT
CERTIFIED**
30 minutes (TYPE 30)



✓
Ideal for storing small quantities.
Cheap implementation compared
with the regulations
on inflammable product storage

PORTABLE, PRACTICAL AND SAFE SAFETY FIRE CASE



SAFETY STORAGE CABINETS FOR INFLAMMABLES

→ TECHNICAL FEATURES:

- Completely made of an electrogalvanized steel plate with a thickness from 1 to 1.5 mm, cold bent - Grey RAL7031
- External finishing made of acidproof epoxy resin and passage through a thermal tunnel at 200 °C
- Cabinet isolation through some high density rock wool panels and some calcium sulphate panels
- Automatic cover closing when the ambient temperature exceeds 50 °C
- 30 mm thermo-expanding isolation seals that in case of temperature rise ensure a perfect box sealing, according to standard EN14470-1
- Optional carriage
- Side handles
- Clover with key lock
- 1 **painted steel** retention tray
- ISO 3864: Pictogram signalling
- Certified as fire-resistant for 30 minutes, according to standard **EN14470-1 BV (Bureau Veritas)**

→ SAFETY FIRE CASE

CODE	DESCRIPTION	EXTERNAL DIMENSIONS (WxDxH) mm	INTERNAL DIMENSIONS (WxDxH) mm	INTERNAL EQUIPMENT	STORAGE CAPACITY*	Weight (Kg)
CSF500	Safety Fire Case Type 30	340x340x400	200x200x265	1 stainless steel retention tray (capacity 1.5 Litres)	4 bottles holding 1litre or 1 bottle holding 5 litres	18

*Capacité approximative en bouteilles de 1 litre par armoire

→ EQUIPMENT (optional)

CODE	DESCRIPTION	DIMENSIONS (WxDxH) mm	RETENTION VOLUME (LITRES)	STORAGE CAPACITY*
CSF550	Wall mounting system	-	-	-
CSF560	Wheeled carriage	-	-	-
TR/EFO	Pipe passage (chromatography)	Ø <2 cm	-	-
ESTINTORE	External carbon dioxide fire-extinguisher with automatic thermal tripping (62 °C)	Ø 90x280	-	-

*Approximate capacity in bottles holding 1 litre

→ APPLICATION: CHROMATOGRAPHIE CPG / HPLC

- Solvent storage in a portable fire-resistant box and bound to the chromatographic chain through some tubing.
- The tubing is connected through a fire-resistant passage with a diameter < 2 cm located on the box cover.
- **Optional Chromatography:** Code: TR/EFO

Safety first during your chromatographic manipulations



WASTE STORAGE TANK

CHEMISAFE offers several solutions allowing safe collection of (flammable or not flammable) liquid wastes coming from the manipulations inside the laboratories.

→ HOW TO CHOOSE YOUR WASTE STORAGE TANK?

Our very big range of safety underbench cabinets allows offering several possible choices of waste storage tanks. The cabinet located below the working surface of the fume cabinet or underbench will be connected either to a basin or to a funnel:

- 1 - Choose your cabinet model from our underbench COMBISTORAGE range H620 mm according to the type of liquids to reject (fire-resistant cabinets or for chemicals)
- 2 - Choose the recovery and bottle filling level detection system as required.

A- Liquid recovery system with contact electronic control of the filling level (probe)

- Cabinet drilling for the discharge pipe passage
- The pipe will pass through the cabinet thanks to a firestop hole certified REI 180 for the use of inflammable products and standard for acids/bases
- Funnel with removable grid made of black HDPE allowing recovering contaminated liquids. - Jerrycans made of HDPE, capacity of 10 litres.
- Electronic level sensor assembled on velcro which can be fixed either on the jerrycan itself, or on the cabinet wall.
- Audible and visual alarm to be placed, for example, on an underbench cabinet back.
- The system will be equipped with a level probe with visual and audible alarm

CODE	DESCRIPTION
CS107953	Controlled exhaust tank (10 litres)
CS106480	Controlled exhaust cap

Connection to an underbench funnel



- Safety funnel made of conductive HPDE. It is equipped with an earth system, and it is delivered with a cable and pliers. A removable sieve allows filtering some solids.
- The small funnel has a cover to close it when it is not used
- The big funnel is equipped with an automatic closing float

Connection to a basin under fume cabinet



B- Filling level control without contact by weighing

This system allows checking the liquid level contained in the bottle and controlling an alarm when the critical level is reached. A relay output (dry contact) is foreseen for this purpose. The system is equipped with an electronic control of the tare weight and of the high level to measure the precise level variations.

→ TECHNICAL FEATURES:

- Power: current network 230Vca / 50Hz
- Consumption: 100 mA
- Minimum capacity: 60 Kg
- Operating temperature : from -10 °C to 50 °C
- Plate dimensions: (WxDxH) 340x340x 340 mm
- Overall dimensions: (WxDxH) 360x360x250 mm
- Degree of protection: IP55
- Relay detector alarm: 1A / 230Vca

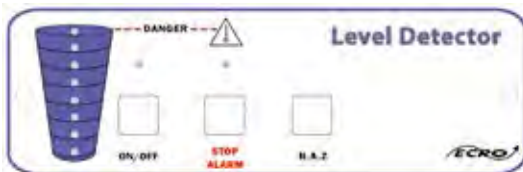

Please contact us to ask for a customized solution

C - Filling level electronic control without contact through optical and acoustic signals

Contactless detection of the container filling level. The sensor sensitivity can be adjusted for the various thicknesses of the existing walls. The signalling box emits some optical and acoustic signals indicating that the filling level defined before has been reached. It is suitable for all non-conductive glass or plastic packaging. It is not suitable for stainless steel containers or for conductive plastic bottles.

- Easy assembly for all non-conductive glass or plastic packaging

- Reusable when the container is empty
- Possibility of monitoring simultaneously several containers
- All signal boxes are delivered with a power supply (110/230V)



Please contact us to ask for a customized solution

FIREPROOF CABINET accessories

Fire-extinguisher

→ **TECHNICAL FEATURES:**

- Automatic fire-extinguisher to be positioned inside or outside the cabinet
- Automatic tripping when the internal temperature of the cabinet exceeds 68 °C



ESTINTORE



Fire-extinguisher installed in a safety cabinet



Fastening system

Visual and audible alarm system with telephone transmission

→ **TECHNICAL FEATURES:**

- **Visual and audible alarm system with telephone transmission equipped with a T probe (°C) located inside the cabinet.** If the temperature setpoint is exceeded, an audible and visual alarm rings on the cabinet and calls one of the 24 prerecorded telephone numbers in the system.
- Temperature range: -40 / +90 °C
- Accuracy: +/- 1 °C
- Resolution: 1 °C



Base plate and wheel board

→ TECHNICAL FEATURES:

- **Base plate** with magnetized cover for pallet truck and **wheel board** to move easily the heaviest cabinets



Detail of the magnetized base plate

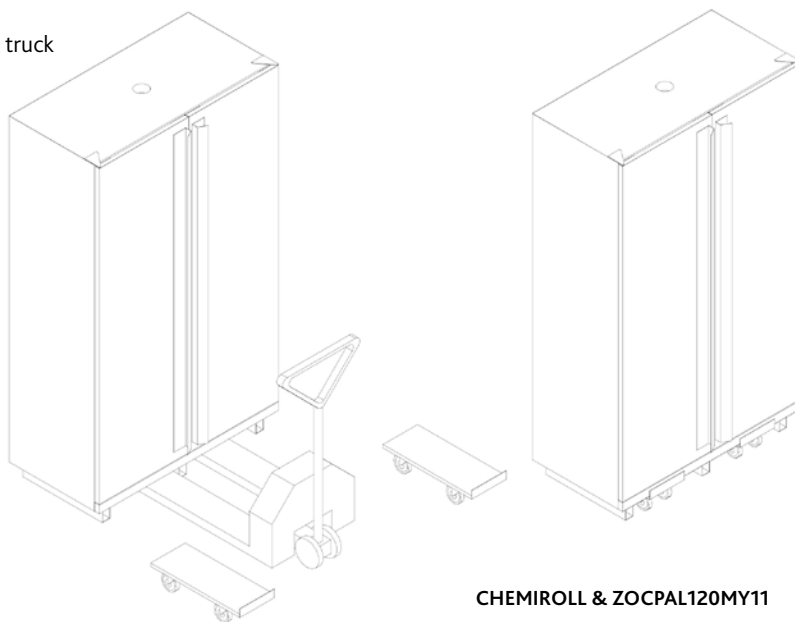

CHEMIROLL & ZOCPAL120MY11

Standard EN14470-2



The European harmonization with regard to the storage of chemicals and of gas cylinders has led to the evolution of the storage regulation of compressed gas cylinders.

That's why the new European standard EN14470-2 replaces standard DIN 12925-2.

➤ WHAT DOES THE STANDARD SAY?

CHEMISAFE puts at your disposal all the certification documents of its cabinets

➔ FIRE RESISTANCE TEST

The introduction of standard EN 14470-2 increases the safety level all over Europe.

This standard prescribes that a cabinet for storing gas cylinders in a building must be fire-resistant.

The cabinet must be conceived and manufactured so that in case of fire its contents do not contribute to increase the risks or to spread fire for at least 15 minutes.

The cabinet is conceived so as to ventilate the internal part in case of reduced gas leakages.

➔ CLASSIFICATION

A safety cabinet for gas cylinders must be classified according to one of the following Types : G15, G30, G60 or G90 minutes.

It is the time for a temperature rise > de 50K (Temperature taken near the tightening plate of the gas cylinder valve).

The flammability class leaves a sufficient time to the staff to leave the area and to firefighters to enter it before the compressed gas cylinders become unstable.

➔ FIRE RESISTANCE

The fire resistance of the compressed gas cylinder storage cabinet must be established through a type test. This type test is carried out by heating the cabinet in an oven according to the time-temperature curve and by measuring the temperature increase on an empty gas cylinder surface located inside the cabinet. The temperature increase on the tightening plate surface of the cylinder valve must not exceed 50 K.

➔ CERTIFICATION

Each type of cabinet and each model must pass a fire test during which it will be tested. If a gap is detected in the measures above the tolerance limits set by the standard, the cabinet model must be tested again. **This test must be carried out by an independent approved body.** When the result of this test is obtained, a conformity certificate to standard EN14470-2 will be delivered and supplied with each cabinet model.

➤ MANUFACTURING

➔ VENTILATION

The cabinets must be equipped with some air inlet and outlet openings allowing connecting a drainage system

- if some inflammable gases that can maintain a fire are used, the cabinet air volume change will be of at least 10 times per hour

- if some toxic gases are used, the cabinet air volume change will be of at least 120 times per hour

The differential pressure must not exceed 150Pa. The ventilation system must keep a pressure inside the cabinet lower than the surrounding atmosphere.

➔ HOW TO HOLD THE GAS CYLINDER

A suitable system must be installed inside the cabinet, to prevent the gas cylinder from tilting.

➔ COMPRESSED GAS CYLINDER INSERTION AND WITHDRAWAL

The cabinet must be manufactured to allow inserting and withdrawing the cylinders with the utmost safety and with the minimum manual effort.

CHEMISAFE provides for an access ramp on all its models.

Safety storage cabinets for gas cylinders

**FIRE-RESISTANT
CERTIFIED**
90 minutes (TYPE 90)

STORAGE CABINETS
FOR GAS CYLINDERS



B120G60

→ GAS SUPPLY LINE INSTALLATION

The number of supply line passages through the cabinet wall or roof must be reduced to the minimum necessary with a maximum of three for each cylinder. The unused holes must be closed. We recommend making the three holes with a diameter of 10 mm each.

→ MARKING

A label must be installed on the front part of the cabinet and it must be readable indicating: the fire resistance class, that the doors must be kept closed, a safety pictogram must signal the presence of compressed gas cylinders, the manufacturer's brand, the model number, the manufacturing year and the serial number.

➤ HOW DID THE FORMER STANDARD

DIN 12925-2 CHANGE?

Due to the modifications on the gas cylinder safety cabinet tests, the former standard DIN12925-2 does not correspond any longer to the higher needs of standard NF EN 14470-2.

After the official issue of standard NF EN 14470-2, standard DIN 12925-2 has been officially replaced starting from December 2006.

➤ MAXIMUM PROTECTION FOR SAFETY FIRST, WHY G90?

For several years in Germany as well as in Europe, the Type 90 classification, for the inflammable liquid storage in safety cabinets has been set as the standard. That's why we chose to offer you only the maximum safety standard G90. Therefore, the safety cabinets for storing under pressure gas cylinders G90 CHEMISAFE meet the strictest manufacturing and test requirements of the new standard NF EN 14470-2.

Due to the lack of a classification for gas cylinder cabinets, the users on site had some different safety levels between the storage of inflammable liquids and of gas cylinders. Therefore, it can be expected that after the appearance of this standard several users will like to reach the same safety level in their gas cylinders of the one already reached for the storage of inflammable liquids thanks to safety cabinets resisting 90 minutes to fire (G90).

➤ WHAT DOES THIS MEAN FOR THE USER?

- A use complying with the regulation
- A certification documentation for each safety cabinet bought
- A maximum safety for the users since in case of fire the staff can leave the building without any danger and the assistance and the firefighters can intervene to reach the cylinder storage place before any more serious fire breaks out because of gas combustion.



Series FIRE BOMB

Certified according to EN14470-2



**FIRE-RESISTANT
CERTIFIED**
30 minutes (TYPE 30)
60 minutes (TYPE 60)

NEW!
Certification EN14470-2



B60G30



B120G30

→ TECHNICAL FEATURES:

- Completely made of an electrogalvanized steel plate with a thickness from 1 to 2 mm, cold bent
- External finishing made of acidproof epoxy resin and passage through a thermal tunnel at 200 °C
- Cabinet isolation through some high density rock wool panels and some calcium sulphate panels (DIN 4102)
- Internal finishing with melamine panels highly resistant to chemical and aggressive vapours
- Structure allowing replacing spare parts if necessary
- Automatic door closing when the ambient temperature exceeds 50 °C
- 30 mm thermo-expanding isolation seals that in case of temperature rise ensure a perfect cabinet sealing
- Air inlet and outlet with certified fire dampers closing ducts when the temperature exceeds 70 °C according to standard DIN 4102-6
- Prearrangement for ventilation through a Ø 100 mm flange for an external connection (see the chapter on ventilation)
- Closing system allowing keeping the door open in any position
- Spark resistant hinge ensuring a perfect door solidity
- Cabinet equipped with earthing
- Leveling jacks
- Gas pipe passage openings with a diameter of 12 mm, located in the middle and on the upper part of the cabinet
- Door key lock
- Front side ramp made of galvanized steel to facilitate loading and manipulations
- 1 galvanized steel shelf for small gas cylinders
- Gas cylinder supports made of electrogalvanized steel delivered with a fixing chain
- ISO 3864: pictogram signalling
- Certified as fire resistant for **30 minutes**, according to standard **EN14470-2 BV (Bureau Veritas)**

→ SERIES FIRE BOMB

CODE	DESCRIPTION	EXTERNAL DIMENSIONS (WxDxH) mm	INTERNAL DIMENSIONS (WxDxH) mm	INTERNAL EQUIPMENT	STORAGE CAPACITY	Weight (Kg)
B60G30	Cabinet series FIRE BOMB with 1 door Type G30	595x600x2050	493x443x1780	1 galvanized steel shelf for small gas cylinders	1 gas cylinder Ø 26 cm or 2 cylinders Ø 21/23 cm	250
B120G30	Cabinet series FIRE BOMB with 2 doors Type G30	1200x600x2050	1092x443x1780	1 galvanized steel shelf for small gas cylinders	3 gas cylinders Ø 26 cm or 4 cylinders Ø 21/23 cm	420
B60G60	Cabinet series FIRE BOMB with 1 door Type G60	700x600x2050	500x365x1780	1 galvanized steel shelf for small gas cylinders	1 gas cylinder Ø 26 cm or 2 cylinders Ø 21/23 cm	275
B120G60	Cabinet series FIRE BOMB with 2 doors Type G60	1400x600x2050	500+500x365x1780	1 galvanized steel shelf for small gas cylinders	3 gas cylinders Ø 26 cm or 4 cylinders Ø 21/23 cm	580

→ INTERNAL EQUIPMENT (optional)

CODE	DESCRIPTION	DIMENSIONS (WxDxH) mm	STORAGE CAPACITY
ACCG30	Additional shelf for small gas cylinder	430x330x250	1 small cylinder
RIPB60	Additional shelf for BOMB60		
RIPB120	Additional shelf for BOMB120		
ESTINTORE	External carbon dioxide fire-extinguisher with automatic thermal tripping (62 °C)	Ø 90x280	-

→ VENTILATION (optional)

CODE	DESCRIPTION	DIMENSIONS (WxDxH) mm
DIAM125BP	Fresh air box with filter holding box for high cabinet with 1 or 2 doors - outlet Ø: 125 mm (filter excluded)	290x290x270
CSF100BPAMY11	Fresh air box ATEX with power cable and filter box – outlet diameter 125 mm	350x370x500
RSOL	Activated charcoal filter for organic solvents (to replace at least twice a year)	235x110x15
GFKIT100	External connection kit (1 metre of hose diam 100 mm and 2 pipe clamps)	Ø 100 - W 1000 mm

*To obtain the complete list of the connection accessories, see the chapter on ventilation of this catalogue and the current price list



Series BBASIC

Safety cabinets for the internal and external storage of gas cylinders



BBASIC60



BBASIC120

The cheap solution
to store
gas cylinders safely



BBASIC60G



BBASIC120G

→ TECHNICAL FEATURES:

- Completely made of an electrogalvanized steel plate (Skin passat) FE P01 with a thickness of 15/10 mm, cold bent and degreased
- External finishing made of epoxy resin and thermosetting powder and passage through a thermal tunnel at 200 °C
- Grey RAL7035
- Construction in one piece with jacks to level the cabinet
- Plain swing doors or with polycarbonate windows
- Door opening at 110°
- Safety closing with lock
- Door opening with an angle of 110°
- External hinge made of plastic resistant to corrosion
- Front side hinged ramp made of steel plate to facilitate loading and manipulations
- Bottle fixing chains
- ISO 3864: Pictogram signalling



→ SERIES BBASIC

CODE	DESCRIPTION	EXTERNAL DIMENSIONS (WxDxH) mm	INTERNAL DIMENSIONS (WxDxH) mm	INTERNAL EQUIPMENT	STORAGE CAPACITY	Weight (Kg)
BBASIC60	Cabinet series BBASIC with 1 plain door	600x600x1950	595x540x1864	1 hinged ramp, chains	From 1 to 2 gas cylinders	70
BBASIC60G	Cabinet series BBASIC with 1 door with window	600x600x1950	595x540x1864	1 hinged ramp, chains	From 1 to 2 gas cylinders	70
BBASIC120	Cabinet series BBASIC with 2 plain doors	1200x600x1950	1130x540x1864	1 hinged ramp, chains	From 3 to 4 gas cylinders	125
BBASIC120G	Cabinet series BBASIC with 2 doors with window	1200x600x1950	1130x540x1864	1 hinged ramp, chains	From 3 to 4 gas cylinders	125



Series PANDESA®

Certified box for the external storage of compressed gas cylinders

→ TECHNICAL FEATURES:

- Manufacturing with steel panels welded to some enclosing side members to prevent the structure deflections
- Box with adjustable feet for fastening to the ground
- Possibility of filling the above-mentioned panels with sand or concrete, and then of fixing them
- Galvanization treatment on all components
- Polyurethane resin paint
- Modular roof made of corrugated cardboard fixed on a supporting basis made of painted steel
- PVC gutter to drain rainwater
- Doors with anti-intrusion grid equipped with a safety lock
- Equipped with continuous earthing for each piece (FARADAY CAGE)
- Extensible structure thanks to modules (the picture shows the model for 3 cylinders, see the drawings below)
- Openings to fix the modules
- Possibility of separating fuel and combustion agent
- No building permit is required
- Authorization from the Ministry of the interior **Certificate No. 3804/30/91**



PAN01

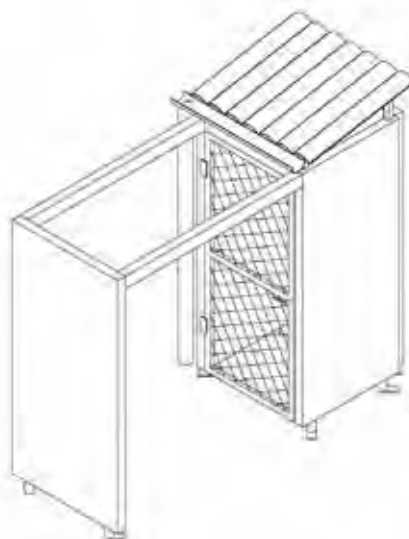

→ DOOR PROTECTION KIT

CODE	DESCRIPTION
PAN01	1 door
PAN02	2 doors

The logical, cheap and modular solution for storing your gas cylinders externally

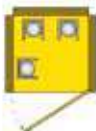

PAN01 - LED3
For 3 gas cylinders
W960 x D880 x H2400mm
Weight: 262 Kg

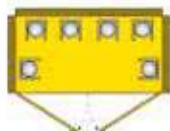

PAN02 - LED6
For 6 gas cylinders
W1760 x D880 x H2400mm
Weight: 377 Kg

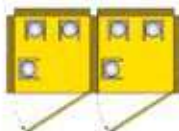

PAN03 - LED3+3
For 3+3 gas cylinders
W1840 x D880 x H2400mm
Weight: 448 Kg

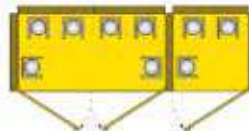

PAN04 - LED6+3
For 6+3 gas cylinders
W2640 x D880 x H2400mm
Weight: 568 Kg



PAN05 - LED10
For 10 gas cylinders
W1760 x D1680 x H2400mm
Weight: 550 Kg

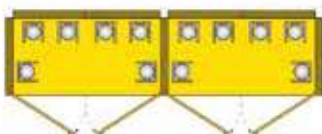

PAN06 - LED6+6
For 6+6 gas cylinders
W3440 x D880 x H2400mm
Weight: 683 Kg

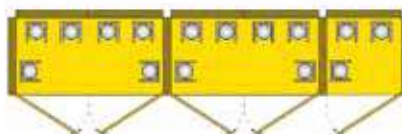

PAN07 - LED6+6+3
For 6+6+3 gas cylinders
W4320 x D880 x H2400mm
Weight: 875 Kg

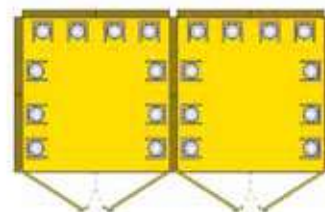

PAN08 - LED10+10
For 10+10 gas cylinders
W3440 x D1680 x H2400mm
Weight: 909 Kg

BOX FOR GAS CYLINDERS

STORAGE CABINETS FOR GAS CYLINDERS



PBOX912

→ TECHNICAL FEATURES:

- Swing door with security lock
- Roof made of galvanized steel
- Internal basis made of non-slip steel
- Earthing
- Internal chain and spring hook to fix the cylinders
- Already prepared to assemble modules
- Safety labelling included



PEDPB RAMP

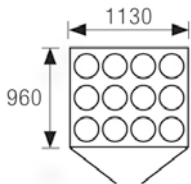

PBOX912
Box from 9 to 12 places
W1130 x D960 x H2100mm
Weight: 175 Kg

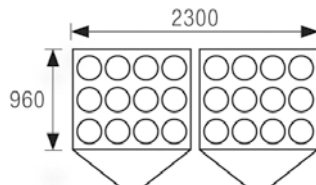

PBOX1824
Box from 18 to 24 places
W2300 x D960 x H2100mm
Weight: 350 Kg

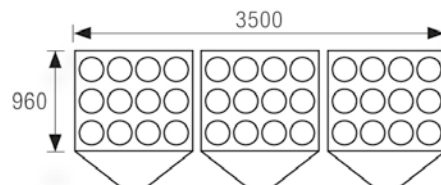

PBOX2436
Box from 24 to 36 places
W3500 x D960 x H2100mm
Weight : 520 Kg

Protect your equipment against the unauthorized people





Series COMBISTORAGE UNDERBENCH

Certified according to EN14470-1, EN61010 & EN16121



Our range of COMBISTORAGE underbench optimizes space in your laboratory! The customized solution to replace your laboratory wooden or steel furniture with a combination of safety cabinets: for acids, bases and inflammables.

How to choose your combination?

- Measure the available space underbench
- If necessary, choose the suitable base plate for the available space
- Choose the cabinet models for acids/bases/inflammables according to your storage needs.

Each cabinet of the COMBISTORAGE underbench range can be combined on some base plates with different widths.

The different widths and heights of our cabinets allow you to find the solution to your storing problems in your laboratory

- Left door / right door / drawer opening
- 13 possible widths: from 400 to 1800 mm
- Base plates: H 70 mm
- All our models are available with 2 heights: 620 mm & 720 mm



In this way you can have a combination of Acids + Bases + inflammables on a unique base plate.



Modular and certified:
the solution for keeping and using hazardous products directly in the laboratory.

→ TECHNICAL FEATURES:

COMBISTORAGE FOR INFLAMMABLES

- Completely made of an electrogalvanized steel plate with a thickness from 1 to 1.5 mm, cold bent - Grey RAL7035
- External finishing made of acidproof epoxy resin and passage through a thermal tunnel at 200 °C
- Cabinet isolation through some high density rock wool panels and some calcium sulphate panels
- Internal finishing panels made of HPL highly resistant to chemical and aggressive vapours
- Structure allowing replacing spare parts if necessary
- Automatic door closing when the ambient temperature exceeds 50 °C
- 30 mm thermo-expanding isolation seals that in case of temperature rise ensure a perfect cabinet sealing, according to standard EN14470-1
- Air inlet and outlet with certified fire dampers closing ducts when the temperature is higher than 70 °C according to standard DIN 4102-6
- Prearrangement for ventilation through a Ø 100 mm flange for an external connection or a filtering ventilation system (see the chapter on ventilation)
- Spark resistant brass hinge ensuring a perfect door solidity
- Cabinet equipped with earthing
- Leveling jacks
- Door and drawer key lock
- Shelves made of **painted steel** or **stainless steel** whose height can be adjusted
- Shelf fastening on some aluminium eyelets excluding any spark risk
- Shelves tested to fire
- ISO 3864: Pictogram signalling
- Certified as resistant to fire for 90 minutes, according to standard **EN14470-1 BV (Bureau Veritas)**
- Certified as complying with standard **EN16121 BV (Bureau Veritas)**

COMBISTORAGE FOR ACIDS / BASES

- Completely made of an electrogalvanized steel plate with a thickness from 1 to 1.5 mm, cold bent - Grey RAL7035
- External finishing made of acidproof epoxy resin and passage through a thermal tunnel at 200 °C
- Internal finishing panels made of HPL highly resistant to chemical and aggressive vapours
- Structure allowing replacing spare parts if necessary
- Prearrangement for ventilation through a Ø 100 mm flange for an external connection or a filtering ventilation system (see the chapter on ventilation)
- Cabinet equipped with earthing
- Leveling jacks
- Door and drawer key lock
- Shelves made of **plasticated steel** or **stainless steel** whose height can be adjusted
- Drawer system made of plasticated steel
- Shelf fastening on some eyelets
- ISO 3864: Pictogram signalling
- Certified as complying with standard **EN61010**
- Certified as complying with standard **EN16121 BV (Bureau Veritas)**











CS716AD



CSFZ150 + CS715AC + CSF706C + CS714BC

→ COMBISTORAGE UNDERBENCH FOR ACIDS / BASES - H 620 / H 720

TYPE OF OPENING	CODE FOR ACIDS	CODE FOR BASES	EXTERNAL DIMENSIONS (WxDxH) mm	INTERNAL DIMENSIONS (WxDxH) mm	STORAGE CAPACITY*	WEIGHT Kg
400 - RIGHT 	CS140AD	CS140BD	395 x 520 x 620	330 x 430 x 530	9	51
	CS714AD	CS714BD	395 x 520 x 720	330 x 430 x 630	18	54
400 - LEFT 	CS140AS	CS140BS	395 x 520 x 620	330 x 430 x 530	9	51
	CS714AS	CS714BS	395 x 520 x 720	330 x 430 x 630	18	54
400 - DRAWER 	CS140AC	CS140BC	395 x 520 x 620	330 x 430 x 530	9	51
	CS714AC	CS714BC	395 x 520 x 720	330 x 430 x 630	9	54
500 - RIGHT 	CS150AD	CS150BD	495 x 520 x 620	430 x 430 x 530	12	53
	CS715AD	CS715BD	495 x 520 x 720	430 x 430 x 630	24	56
500 - LEFT 	CS150AS	CS150BS	495 x 520 x 620	430 x 430 x 530	12	53
	CS715AS	CS715BS	495 x 520 x 720	430 x 430 x 630	24	56
500 - DRAWER 	CS150AC	CS150BC	495 x 520 x 620	430 x 430 x 530	12	53
	CS715AC	CS715BC	495 x 520 x 720	430 x 430 x 630	12	56
600 - RIGHT 	CS160AD	CS160BD	595 x 520 x 620	530 x 430 x 530	15	55
	CS716AD	CS716BD	595 x 520 x 720	530 x 430 x 630	30	58
600 - LEFT 	CS160AS	CS160BS	595 x 520 x 620	530 x 430 x 530	15	55
	CS716AS	CS716BS	595 x 520 x 720	530 x 430 x 630	30	58
600 - DRAWER 	CS160AC	CS160BC	595 x 520 x 620	530 x 430 x 530	15	55
	CS716AC	CS716BC	595 x 520 x 720	530 x 430 x 630	15	58

*Approximate capacity in bottles holding 1 litre
 Standard colour Grey RAL7035, add « Y » to the code for a yellow cabinet RAL1021. For stainless steel shelves, replace « V » with « X » in the item code.
 Base plate not compulsory, to be added if necessary.

→ COMBISTORAGE UNDERBENCH FOR ACIDS / BASES - H 620 / H 720

TYPE OF OPENING	CODE ACIDS + BASES	EXTERNAL DIMENSIONS (WxDxH) mm	INTERNAL DIMENSIONS (WxDxH) mm	STORAGE CAPACITY*	WEIGHT Kg
890 - 2 DOORS 	CS190AB	890 x 520 x 620	425 + 425 x 430 x 530	9 + 9	99
	CS719AB	890 x 520 x 720	425 + 425 x 430 x 630	18 + 18	99
890 - DRAWER 	CS190CAB	890 x 520 x 620	425 + 425 x 430 x 530	9 + 9	99
	CS719CAB	890 x 520 x 720	425 + 425 x 430 x 630	9 + 9	99
1000 - 2 DOORS 	CS100AB	990 x 520 x 620	450 + 450 x 430 x 530	10 + 10	104
	CS710AB	990 x 520 x 720	450 + 450 x 430 x 630	20 + 20	110
1000 - DRAWER 	CS100CAB	990 x 520 x 620	450 + 450 x 430 x 530	10 + 10	104
	CS710CAB	990 x 520 x 720	450 + 450 x 430 x 630	10 + 10	110
1100 - 2 DOORS 	CS110AB	1090 x 520 x 620	490 + 490 x 430 x 530	12+12	104
	CS711AB	1090 x 520 x 720	490 + 490 x 430 x 630	24 + 24	114
1100 - DRAWER 	CS110CAB	1090 x 520 x 620	490 + 490 x 430 x 530	12 + 12	104
	CS711CAB	1090 x 520 x 720	490 + 490 x 430 x 630	12 + 12	114

*Approximate capacity in bottles holding 1 litre
Standard colour Grey RAL7035, add « Y » to the code for a yellow cabinet RAL1021. For stainless steel shelves, replace « V » with « X » in the item code.
Base plate not compulsory, to be added if necessary.

→ BASE PLATES





CODE	DIMENSIONS (WxDxH) mm
CSFZ40	400 x 500 x 70
CSFZ50	500 x 500 x 70
CSFZ60	600 x 500 x 70
CSFZ80	800 x 500 x 70
CSFZ90	900 x 500 x 70
CSFZ100	1000 x 500 x 70
CSFZ110	1100 x 500 x 70
CSFZ120	1200 x 500 x 70
CSFZ140	1400 x 500 x 70
CSFZ150	1500 x 500 x 70
CSFZ160	1600 x 500 x 70
CSFZ170	1700 x 500 x 70
CSFZ180	1800 x 500 x 70



Retention shelves made of painted steel

CERTIFIED
COMBISTORAGE
CABINETS SERIES

→ **COMBISTORAGE UNDERBENCH FOR INFLAMMABLES TYPE 90 - H 620 / H 720**

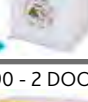
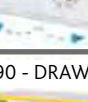
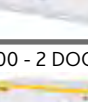
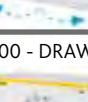
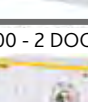
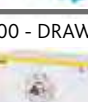
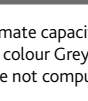
TYPE OF OPENING	CODE FOR INFLAMMABLES TYPE 90	EXTERNAL DIMENSIONS (WxDxH) mm	INTERNAL DIMENSIONS (WxDxH) mm	STORAGE CAPACITY*	WEIGHT Kg
500 - RIGHT 	CSF605D	495 x 520 x 620	383 x 349 x 493	12	73
	CSF705D	495 x 520 x 720	383 x 349 x 593	12	78
500 - LEFT 	CSF605S	495 x 520 x 620	383 x 349 x 493	12	73
	CSF705S	495 x 520 x 720	383 x 349 x 593	12	78
500 - DRAWER 	CSF605C	495 x 520 x 620	383 x 349 x 493	12	73
	CSF705C	495 x 520 x 720	383 x 349 x 593	12	78
600 - RIGHT 	CSF606D	595 x 520 x 620	483 x 349 x 493	15	82
	CSF706D	595 x 520 x 720	483 x 349 x 593	15	87
600 - LEFT 	CSF606S	595 x 520 x 620	483 x 349 x 493	15	82
	CSF706S	595 x 520 x 720	483 x 349 x 593	15	87
600 - DRAWER 	CSF606C	595 x 520 x 620	483 x 349 x 493	15	82
	CSF706C	595 x 520 x 720	483 x 349 x 593	15	87
890 - 2 DOORS 	CSF 609	890 x 520 x 620	778 x 349 x 493	25	105
	CSF 709	890 x 520 x 720	778 x 349 x 593	25	110
890 - DRAWER 	CSF 609C	890 x 520 x 620	778 x 349 x 493	25	105
	CSF 709C	890 x 520 x 720	778 x 349 x 593	25	110
1000 - 2 DOORS 	CSF610	990 x 520 x 620	878 x 349 x 493	27	118
	CSF710	990 x 520 x 720	878 x 349 x 593	27	125
1000 - DRAWER 	CSF610C	990 x 520 x 620	878 x 349 x 493	27	118
	CSF710C	990 x 520 x 720	878 x 349 x 593	27	125
1100 - 2 DOORS 	CSF611	1090 x 520 x 620	978 x 349 x 493	30	134
	CSF711	1090 x 520 x 720	978 x 349 x 593	30	139
1100 - DRAWER 	CSF611C	1090 x 520 x 620	978 x 349 x 493	30	134
	CSF711C	1090 x 520 x 720	978 x 349 x 593	30	139

→ **BASE PLATES**

CODE	DIMENSIONS (WxDxH) mm
CSFZ40	400 x 500 x 70
CSFZ50	500 x 500 x 70
CSFZ60	600 x 500 x 70
CSFZ80	800 x 500 x 70
CSFZ90	900 x 500 x 70
CSFZ100	1000 x 500 x 70
CSFZ110	1100 x 500 x 70
CSFZ120	1200 x 500 x 70
CSFZ140	1400 x 500 x 70
CSFZ150	1500 x 500 x 70
CSFZ160	1600 x 500 x 70
CSFZ170	1700 x 500 x 70
CSFZ180	1800 x 500 x 70



CSF705C

*Approximate capacity in bottles holding 1 litre.

Standard colour Grey RAL7035, add « Y » to the code for a yellow cabinet RAL1021. For stainless steel shelves, replace « V » with « X » in the item code.

Base plate not compulsory, to be added if necessary.



Retention tray with painted steel grid



CSF611 + CSFZ110



Cabinet levelling.



Double isolation system preventing noxious vapours from coming out and hot air from entering in case of fire.



CSF605C + CS160AD + base plate CSFZ110

→ INTERNAL EQUIPMENT (optional)

CODE	DESCRIPTION	DIMENSIONS (WxDxH) mm	RETENTION VOLUME (LITRES)	STORAGE CAPACITY*
SHELVES FOR COMBISTORAGE INFLAMMABLES - shelves tested to fire				
RIPF50V	Additional shelf made of painted steel for cabinet with 1 door W500	380x320x39	4	12
RIPF50I	Additional shelf made of stainless steel for cabinet with 1 door W500	380x320x39	4	12
RIPF60V	Additional shelf made of painted steel for cabinet with 1 door W600	480x320x39	6	15
RIPF60I	Additional shelf made of stainless steel for cabinet with 1 door W600	480x320x39	6	15
RIPF90V	Additional shelf made of painted steel for cabinet with 1 door W900	775 x320x39	9	27
RIPF90I	Additional shelf made of stainless steel for cabinet with 1 door W900	775 x320x39	9	27
RIPF100V	Additional shelf made of painted steel for cabinet with 2 doors W1000	875x320x39	11	28
RIPF100I	Additional shelf made of stainless steel for cabinet with 2 doors W1000	875x320x39	11	28
RIPF110V	Additional shelf made of painted steel for cabinet with 2 doors W1100	975x320x39	12	30
RIPF110I	Additional shelf made of stainless steel for cabinet with 2 doors W1100	975x320x39	12	30

SLIDING SHELVES FOR COMBISTORAGE INFLAMMABLES				
RIPF50VS	Additional sliding shelf made of painted steel for S50UBS	284x320x39	4	12
RIPF50IS	Additional sliding shelf made of stainless steel for S50UBS	284x320x39	4	12
S50UBS	Frame for pull-out shelf for FIRE 50UB (shelf not included)			
RIPF60VS	Additional sliding shelf made of painted steel for S60UBS	384x320x39	5	15
RIPF60IS	Additional sliding shelf made of stainless steel for S60UBS	384x320x39	5	15
S60UBS	Frame for pull-out shelf for FIRE 60UB (shelf not included)			
RIPF90VS	Additional sliding shelf made of painted steel for S90UBS	608x320x39	8	27
RIPF90IS	Additional sliding shelf made of stainless steel for S90UBS	608x320x39	8	27
S90UBS	Frame for pull-out shelf for FIRE 90UB (shelf not included)			
RIPF100VS	Additional sliding shelf made of painted steel for S100UBS	708x320x39	10	28
RIPF100IS	Additional sliding shelf made of stainless steel for S100UBS	708x320x39	10	28
S100UBS	Frame for pull-out shelf for FIRE 100UB (shelf not included)			
RIPF110VS	Additional sliding shelf made of painted steel for S110UBS	808x320x39	11	30
RIPF9110IS	Additional sliding shelf made of stainless steel for S110UBS	808x320x39	11	30
S110UBS	Frame for pull-out shelf for FIRE 110UB (shelf not included)			

SHELVES FOR COMBISTORAGE ACIDS				
RIPCS140V	Additional shelf made of plasticated steel for cabinet with 1 door W400	325x400x39	5	9
RIPCS150V	Additional shelf made of plasticated steel for cabinet with 1 door W500	425x400x39	7	12
RIPCS160V	Additional shelf made of plasticated steel for cabinet with 1 door W600	525x400x39	8	12
RIPCS190V	Additional shelf made of plasticated steel for cabinet with 1 door W900	395x400x39	6	9
RIPCS100V	Additional shelf made of plasticated steel for cabinet with 2 doors W1000 (for acids)	447x400x39	6	12
RIPCS110V	Additional shelf made of plasticated steel for cabinet with 2 doors W1100 (for acids)	493x400x39	7	12

SHELVES FOR COMBISTORAGE BASES				
RIPCS140I	Additional shelf made of stainless steel for cabinet with 1 door W400	325x400x39	5	9
RIPCS150I	Additional shelf made of stainless steel for cabinet with 1 door W500	425x400x39	7	12
RIPCS160I	Additional shelf made of stainless steel for cabinet with 1 door W600	525x400x39	8	12
RIPCS190I	Additional shelf made of stainless steel for cabinet with 1 door W900	395x400x39	6	9
RIPCS100I	Additional shelf made of stainless steel for cabinet with 2 doors W1000 (for bases)	447x400x39	6	12
RIPCS110I	Additional shelf made of stainless steel for cabinet with 2 doors W1100 (for bases)	493x400x39	7	12

→ INTERNAL EQUIPMENT (optional)

CODE	DESCRIPTION	DIMENSIONS (WxDxH) mm	RETENTION VOLUME (LITRES)	STORAGE CAPACITY*
SLIDING SHELVES FOR COMBISTORAGE ACIDS AND BASES				
RIPCS140VS	Additional sliding shelf made of plasticated steel for S40ABS	265x395x39	3	9
RIPCS140IS	Additional sliding shelf made of stainless steel for S40ABS	265x395x39	3	9
S40ABS	Frame for pull-out shelf for CS 40UB (shelf not included)			
RIPCS150VS	Additional sliding shelf made of plasticated steel for S50ABS	365x395x39	5	12
RIPCS150IS	Additional sliding shelf made of stainless steel for S50ABS	365x395x39	5	12
S50ABS	Frame for pull-out shelf for CS 50UB (shelf not included)			
RIPCS160VS	Additional sliding shelf made of plasticated steel for S60ABS	465x395x39	6	15
RIPCS160IS	Additional sliding shelf made of stainless steel for S60ABS	465x395x39	6	15
S60ABS	Frame for pull-out shelf for CS 60UB (shelf not included)			
RIPCS190VS	Additional sliding shelf made of plasticated steel for S90ABS	335x395x39	4	9
RIPCS190IS	Additional sliding shelf made of stainless steel for S90ABS	335x395x39	4	9
S90ABS	Frame for pull-out shelf for CS 90UB (shelf not included)			
RIPCS100VS	Additional sliding shelf made of plasticated steel for S100ABS	387x395x39	5	10
RIPCS100IS	Additional sliding shelf made of stainless steel for S100ABS	387x395x39	5	10
S100ABS	Frame for pull-out shelf for CS 100UB (shelf not included)			
RIPCS110VS	Additional sliding shelf made of plasticated steel for S110ABS	433x395x39	6	12
RIPCS110IS	Additional sliding shelf made of stainless steel for S110ABS	433x395x39	6	12
S110ABS	Frame for pull-out shelf for CS 110UB (shelf not included)			

ACCESSORIES				
AT100	Visual and audible alarm system with telephone transmission equipped with a digital thermostat with a T probe (°C) inside the cabinet	-	-	-
TIM24	Daily counter	-	-	-
ESTINTORE	Internal carbon dioxide fire-extinguisher with automatic thermal tripping (62 °C)	Ø 90x280	-	-
KIT4RUOTE	Set of 4 wheels (2 self-locking) for underbench cabinets (H 105 mm)	(H 105 mm)	-	-
KIT4RUOTE/10	Set of 4 wheels (2 self-locking) for underbench cabinets (H 100 mm)	(H 100 mm)	-	-

*Approximate capacity in bottles holding 1 litre

→ VENTILATION (optional)

CODE	DESCRIPTION	DIMENSIONS (WxDxH) mm
DIAM125BP	Fresh air box with filter holding box for high cabinet with 1 or 2 doors - outlet Ø: 125 mm (filter excluded)	290x290x270
CSF100BPAMY11	Fresh air box ATEX with power cable and filter box - outlet diameter 125 mm	350x370x500
RSOL	Activated charcoal filter (to replace at least twice a year)	235x110x15
F100	Ø 100 mm connecting flange for motor CSF100BPMY11 (compulsory to ventilate the underbench cabinets)	Ø 100 mm
KIT2A	Connection kit for TWO cabinets (flexible sheath, tee, clamps) (factory assembly)	Ø 100 mm
KIT3A	Connection kit cabinets (flexible sheath, tee, clamps) (factory assembly)	Ø 100 mm
GFKIT100	External connection kit (1 metre of hose diam. 100 mm and 2 clamps)	Ø 100 - L1000 mm
CS125/100	Ventilation kit for Combistorage acids and bases	
CFNUB	Certified filter unit according to standard NFX15-211 for underbench cabinets, equipped with wheels, 2 ventilation outlets, with visual and audible alarm	400x500x650
CFNUBL	Filter unit manufactured for underbench cabinets, equipped with wheels, 2 ventilation outlets	400x500x650
CFNCO	Hour counter for CFN	
CSAS	Activated charcoal filter for solvents (prefilter included)	510x405x60
CSBE	Activated charcoal filter for acids (prefilter included)	510x405x60
CSMP	Activated charcoal filter for solvents and acids (prefilter included)	510x405x60
CSPF	Prefilter	510x405x15

*To obtain the complete list of the connection accessories, see the chapter on ventilation of this catalogue and the current price list



Series COMBISTORAGE 2C

Certified according to EN14470-1, EN61010 & EN16121

Modular solutions
to the Laboratory Service



CS260



CS360



CS360C

→ TECHNICAL FEATURES:

- Completely made of stainless steel electrogalvanized AISI304 with a thickness from 1 to 1.5 mm, cold bent - Grey RAL7035
- External finishing made of acidproof epoxy resin and passage through a thermal tunnel at 200 °C

Two separate compartments (high and low), for inflammables and acids/bases:

COMPARTMENT TYPE 90 FOR INFLAMMABLES

- Cabinet isolation through some high density rock wool panels and some calcium sulphate panels for the inflammable compartment
- Internal finishing with melamine panels highly resistant to chemical and aggressive vapours
- Structure allowing replacing spare parts if necessary
- Automatic door closing when the ambient temperature exceeds 50 °C
- 30 mm thermo-expanding isolation seals that in case of temperature rise ensure a perfect cabinet sealing, according to standard EN14470-1
- Air inlet and outlet with certified fire dampers closing ducts when the temperature exceeds 70 °C according to standard DIN 4102-6
- **Closing system allowing keeping the door open in any position** and closing it automatically in case of ambient temperature higher than 50 °C
- Spark resistant hinge ensuring a perfect door solidity

- Possibility of having a cabinet with door or drawer according to the models
- Key lock
- Equipped with a retention tray with grid made of painted steel serving as shelf

COMPARTMENT FOR ACIDS/BASES

- Internal finishing with melamine panels highly resistant to chemical and aggressive vapours
- Structure allowing replacing spare parts if necessary
- Door opening with an angle higher than 110°
- Key lock
- Retention shelf made of plasticated steel and stainless steel whose height can be adjusted
- Cabinet equipped with an integrated ventilation system with external connection or prearranged for ventilation through a Ø 100 mm flange
- Cabinet equipped with earthing
- Leveling jacks
- ISO 3864: Pictogram signalling
- Cabinets certified according to standards **EN14470-1, EN61010 and EN16121**
- Certified as fire resistant for **90 minutes**

→ SERIE COMBISTORAGE 2C

CODE	DESCRIPTION	EXTERNAL DIMENSIONS (WxDxH) mm	INTERNAL DIMENSIONS (WxDxH) mm	INTERNAL EQUIPMENT	STORAGE CAPACITY*	Weight Kg
CS260	Combistorage without ventilation system Acids/Bases: door Inflammables: door	595x600x1650	Acids/Bases: 530x430x630 Inflammables: 483x349x593	Acids/Bases: 1 shelf made of plasticated steel and 1 shelf made of stainless steel (max load 60 Kg evenly distributed) Inflammables: 1 retention tray with grid made of painted steel	30 (Acids/Bases) 15 (Inflammables)	145
CS260C	Combistorage without ventilation system Acids/Bases: door Inflammables: drawer	595x600x1650	Acids/Bases: 530x430x630 Inflammables: 483x349x593	Acids/Bases: 1 shelf made of plasticated steel and 1 shelf made of stainless steel (max load 60 Kg evenly distributed) Inflammables: 1 retention tray with grid made of painted steel	30 (Acids/Bases) 15 (Inflammables)	145
CS360	Combistorage with ventilation system and filter Acids/Bases: door Inflammables: door	595x600x1950	Acids/Bases: 530x430x630 Inflammables: 483x349x593	Acids/Bases: 1 shelf made of plasticated steel and 1 shelf made of stainless steel (max load 60 Kg evenly distributed) Inflammables: 1 retention tray with grid made of painted steel	30 (Acids/Bases) 15 (Inflammables)	170
CS360C	Combistorage with ventilation system and filter Acids/Bases: door Inflammables: drawer	595x600x1950	Acids/Bases: 530x430x630 Inflammables: 483x349x593	Acids/Bases : 1 shelf made of plasticated steel and 1 shelf made of stainless steel (max load 60 Kg evenly distributed) Inflammables: 1 retention tray with grid made of painted steel	30 (Acids/Bases) 15 (Inflammables)	170

*Approximate capacity in bottles holding 1 litre per cabinet

→ INTERNAL EQUIPMENT (optional)

CODE	DESCRIPTION	DIMENSIONS (WxDxH) mm	RETENTION VOLUME (LITRES)	STORAGE CAPACITY*
RIPCS260V	Additional shelf made of plasticated steel for acid compartment	530x420x39	8	15
RIPCS260	Additional shelf made of stainless steel for basis compartment	530x420x39	8	15
RIPF60V	Additional shelf made of painted steel for inflammable compartment	480x320x39	6	15
RIPF60I	Additional shelf made of stainless steel for inflammable compartment	480x320x39	6	15
ZOCPAL60MY11	Base plate for pallet truck W600	595x600x110	-	-
CHEMIROLL	Wheel board to move cabinets (the code ZOCPALMY11 is necessary)	-	-	-
AT100	Visual and audible alarm system with telephone transmission equipped with a digital thermostat with a T probe (°C) inside the cabinet	-	-	-
TIM24	Daily counter	-	-	-
ESTINTORE	Internal carbon dioxide fire-extinguisher with automatic thermal tripping (62 °C)	Ø 90x280	-	-

*Approximate capacity in bottles of 1 litre

→ VENTILATION (optional)

CODE	DESCRIPTION	DIMENSIONS (WxDxH) mm
DIAM125BP	Fresh air box with filter holding box for high cabinet with 1 or 2 doors - outlet Ø: 125 mm (filter excluded)	290x290x270
BP100MY11	Filter box	-
RSOL	Activated charcoal filter (to replace at least twice a year)	235x110x15
GFKIT100	External connection kit (1 metre of hose diam 100 mm and 2 clamps)	Ø 100 - W 1000 mm
CFN	Fresh air box with molecular filtration according to standard NFX15-211 (only for models CS260 & CS260C), with visual and audible alarm	550x500x220
CFNL	Molecular filtration box manufactured, without alarm (only for models CS260 & CS260C)	550x500x220
CFNCO	Hour counter for CFN	
CSAS	Activated charcoal filter for solvents (prefilter included)	510x405x60
CSBE	Activated charcoal filter for acids (prefilter included)	510x405x60
CSMP	Activated charcoal filter for solvents and acids (prefilter included)	510x405x60
CSPF	Prefilter	510x405x15

*To obtain the complete list of the connection accessories, see the chapter on ventilation of this catalogue and the current price list



Series COMBISTORAGE 3C AND 4C

Certified according to EN14470-1, EN61010 & EN16121



CS343MY11



CS342MY11



CS344MY11+CFN

Separate storage of inflammables (EN14470-1) and chemicals (EN61010-1)

→ TECHNICAL FEATURES:

- Completely made of an electrogalvanized steel plate with a thickness from 1 to 1.5 mm, cold bent - Grey RAL7035
- External finishing made of acidproof epoxy resin and passage through a thermal tunnel at 200 °C
- Cabinet prearranged for ventilation
- Cabinet equipped with earthing
- Leveling jacks
- ISO 3864: Pictogram signalling
- Certified as fire resistant for **90 minutes**
- Cabinets certified according to standards: **EN14470-1, EN61010 and EN16121**

COMPARTMENT TYPE 90 FOR INFLAMMABLES

- Cabinet isolation through some high density rock wool panels and some calcium sulphate panels for the inflammable compartment
- Internal finishing with melamine panels highly resistant to chemical and aggressive vapours
- Structure allowing replacing spare parts if necessary
- Automatic door closing when the ambient temperature exceeds 50 °C
- 30 mm thermo-expanding isolation seals that in case of temperature rise ensure a perfect cabinet sealing, according to standard EN14470-1
- Air inlet and outlet with fire dampers closing ducts when the temperature is higher than 70 °C according to standard DIN 4102-6
- **Door closing and locking system allowing keeping doors open** and closing them automatically in case of ambient temperature higher than 50 °C

- Spark resistant hinge ensuring a perfect door solidity
- Key lock
- Equipped with three retention shelves and with a retention tray with grid made of painted steel serving as shelf

COMPARTMENT FOR ACIDS/BASES/TOXICS

- Made of two or three compartments with painted plain or glazed doors
- Cabinet body made of galvanized steel

Compartment for «Acids»

- Two retention shelves made of plasticated steel, whose height can be adjusted
- Door opening with an angle higher than 110°
- Key lock
- Complies with standard EN 61010-1 & CEI 66-5
- Storage capacity: 40 bottles holding 1L (20L per shelf)

Compartment for «Bases»

- Two retention shelves made of stainless steel, whose height can be adjusted
- Door opening with an angle higher than 110°
- Key lock
- Complies with standards EN 61010-1 & CEI 66-5
- Storage capacity: 40 bottles holding 1L (20L per shelf)

Compartment for «Toxics»

- Two retention shelves made of painted steel, whose height can be adjusted
- Ouverture des portes avec un angle de plus de 110°
- Key lock
- Complies with standards EN 61010-1 & CEI 66-5
- Storage capacity: 40 bottles holding 1L (20 L per shelf)

→ SERIES COMBISTORAGE 3C AND 4C

CODE	DESCRIPTION	EXTERNAL DIMENSIONS (WxDxH) mm	INTERNAL DIMENSIONS (WxDxH) mm	INTERNAL EQUIPMENT	STORAGE CAPACITY*	Weight Kg
CS343MY11	Combistorage 3 Inflammables: 1 plain door Acids/Bases: 2 compartments, 2 plain doors	1200x600x1950	Inflammables: 496x446x1540 Acids/Bases: 2x590x500x880	Acids: 2 shelves made of plasticated steel Bases: 2 shelves made of stainless steel Inflammables: 3 shelves and 1 retention tray with grid made of painted steel (max load 60 Kg evenly distributed)	40+40 (Acids/Bases) 120 (Inflammables)	310
CS342MY11	Combistorage 4 Inflammables: 1 plain door Acids/Bases: 3 compartments, 3 plain doors	1200x600x1950	Inflammables: 496x446x1540 Acids/Bases/ Toxics: 3x590x500x880	Acids: 2 shelves made of plasticated steel Bases: 2 shelves made of stainless steel Toxics: 2 shelves made of painted steel Inflammables: 3 shelves and 1 retention tray with grid made of painted steel (max load 60 Kg evenly distributed)	40+40+40 (Acids/Bases/ Toxics) 120 (Inflammables)	313
CS344MY11	Combistorage 4 Inflammables: 1 plain door Acids/Bases: 3 compartments, 3 glazed doors	1200x600x1950	Inflammables: 496x446x1540 Acids/Bases/ Toxics: 3x590x500x880	Acids: 2 shelves made of plasticated steel Bases: 2 shelves made of stainless steel Toxics: 2 shelves made of painted steel Inflammables: 3 shelves and 1 retention tray with grid made of painted steel (max load 60 Kg evenly distributed)	40+40+40 (Acids/Bases/ Toxics) 120 (Inflammables)	315

*Approximate capacity in bottles holding 1 litre per cabinet

→ INTERNAL EQUIPMENT (optional)

CODE	DESCRIPTION	DIMENSIONS (WxDxH) mm	RETENTION VOLUME (LITRES)	STORAGE CAPACITY*
RIP60VMY11	Additional shelf made of painted steel for inflammable compartment	493x420x39	7	30
RIP60MY11	Additional shelf made of stainless steel for inflammable compartment	493x420x39	7	30
RIPCS60	Additional fixed shelf made of plasticated steel for acid	485x545x30	9	35
RIPX60	Additional fixed shelf made of stainless steel for basis compartment	485x545x30	9	35
RIP60SC	« Sliding shelf »: sliding system to be added to the shelf (only for cabinets with 1 door or cabinets with 2 compartments)	-	-	-
RIPGI	Additional rotating shelf for cabinet with 1 door			
VACS60	Additional retention tray made of plasticated steel for acid	485x545x70	18	35
VA60PP	Additional retention tray made of polypropylene	485x545x70	18	35
PS50SMY11	Replacing system with closing thermal fuse - left door	-	-	-
ZOCPAL120MY11	Base plate for pallet truck W1200	1200x600x110	-	-
CHEMIROLL	Wheel board to move the cabinets (the code ZOCPALMY11 is necessary)	-	-	-
AT100	Visual and audible alarm system with telephone transmission equipped with a digital thermostat with a T probe (°C) inside the cabinet			
TIM24	Daily counter	-	-	-
ESTINTORE	Internal carbon dioxide fire-extinguisher with automatic thermal tripping (62 °C)	Ø 90x280	-	-

*Approximate capacity in bottles holding 1 litre

→ VENTILATION (optional)

CODE	DESCRIPTION	DIMENSIONS (WxPxH) mm
CSF120MY11	Suction system for Combistorage 3C and 4C - outlet Ø: 100 mm	1200x510x300
BP100MY11	Filter box	-
RSOL	Activated charcoal filter for inflammable compartment - (to replace at least twice a year)	235x110x15
GFKIT100	External connection kit (1 metre of flexible people diam 100 mm and 2 clamps)	Ø 100 - W 1000 mm
CFN	Fresh air box with molecular filtration according to standard NFX15-211, with visual and audible alarm	550x500x220
CFNL	Molecular filtration box manufactured, without alarm	550x500x220
CFNCO	Hour counter for CFN	
ADMY11CFN	Adapter for CFN box	850x500x80
CSAS	Activates charcoal filter for solvents (prefilter included)	510x405x60
CSBE	Activated charcoal filter for acids (prefilter included)	510x405x60
CSMP	Activated charcoal filter for solvents and acids (prefilter included)	510x405x60
CSPF	Prefilter	510x405x15

*To obtain the complete list of the connection accessories, see the chapter on ventilation of this catalogue and the current price list



Series COMBISTORAGE 120 FIRE TYPE 90

Certified according to EN14470-1 & EN16121



CSF232/4C



CSF232/2C



CSF232/3C

The maximum safety for all your products.
Partitioned cabinet completely fire-resistant TYPE 90



→ TECHNICAL FEATURES:

- Completely made of a galvanized steel plate with a thickness from 1 to 1.5 mm, cold bent - Grey RAL7035
- External finishing made of acidproof epoxy resin and passage through a thermal tunnel at 200 °C
- Cabinet isolation through some high density rock wool panels and some calcium sulphate panels
- Internal finishing with melamine panels highly resistant to chemical and aggressive vapours
- Structure allowing replacing spare parts if necessary
- Automatic door closing when the ambient temperature exceeds 50 °C
- 30 mm thermo-expanding isolation seals that in case of temperature rise ensuring a perfect cabinet sealing, according to standard EN14470-1
- Air inlet and outlet with certified fire dampers closing ducts when the temperature exceeds 70 °C according to standard DIN 4102-6
- Prearrangement for ventilation through a Ø 100 mm flange for an external connection or a filtering ventilation system (see the chapter on ventilation)
- **Door closing and locking system allowing keeping the doors open** and closing them automatically if the ambient temperature is higher than 50 °C
- Spark resistant hinge ensuring a perfect door solidity
- Cabinet equipped with earthing
- Leveling jacks
- Door key lock

- Shelves made of painted steel or of stainless steel whose height can be adjusted
- Shelf fastening on some aluminium or copper eyelets excluding any spark risk
- Shelves tested to fire
- ISO 3864: Pictogram signalling
- Cabinets certified according to standards EN14470 and EN16121

INTERNAL COMPARTMENTS to store various families of chemicals:

- Separation by means of panels made of HPL with a thickness of 18 mm coated with thermo-expanding seals (possibility of having up to 3 compartments and of customizing compartments - please contact us)

Compartment for «Inflammables»

- 3 retention shelves whose height can be adjusted and 1 retention tray with grid made of epoxy painted steel

Compartment for «Toxics»

- 1 retention shelf whose height can be adjusted made of epoxy painted steel

Compartment for «Acids»

- 2 retention shelves whose height can be adjusted made of epoxy plasticated steel

Compartment for «Bases»

- 2 retention shelves whose height can be adjusted made of stainless steel

→ SERIES COMBISTORAGE FIRE 120 TYPE 90

CODE	DESCRIPTION	EXTERNAL DIMENSIONS (WxDxH) m	INTERNAL DIMENSIONS (WxDxH) mm	INTERNAL EQUIPMENT	STORAGE CAPACITY*	Weight Kg
CSF232/2C	Cabinet series COMBISTORAGE T90 with 2 doors 2 compartments	1200x600x1950	540+540x446x1540	COMPARTMENT FOR INFLAMMABLES: 3 shelves made of painted steel + 1 retention tray with grid COMPARTMENT FOR ACIDS/BASES: 3 shelves made of plasticated steel (max load 60 Kg evenly distributed)	180	378
CSF232/3C	Cabinet series COMBISTORAGE T90 with 2 doors 3 compartments	1200x600x1950	540+540x446x1540 (760+760 for compartment for acids/bases)	COMPARTMENT FOR INFLAMMABLES: 3 shelves made of painted steel + 1 retention tray with grid COMPARTMENT FOR ACIDS: 2 shelves made of plasticated steel COMPARTMENT FOR BASES: 2 shelves made of stainless steel (max load 60 Kg evenly distributed)	240	378
CSF232/4C	Cabinet series COMBISTORAGE T90 with 2 doors 4 compartments	1200x600x1950	540+540x446x1540 (600+600+300 for compartment for acids/bases/toxics)	COMPARTMENT FOR INFLAMMABLES: 3 shelves made of painted steel + 1 retention tray with grid COMPARTMENT FOR ACIDS: 2 shelves made of plasticated steel COMPARTMENT FOR BASES: 2 shelves made of stainless steel COMPARTMENT FOR TOXICS: 1 shelf made of painted steel (max load 60 Kg evenly distributed)	270	378

*Approximate capacity in bottles holding 1 litre per cabinet

→ INTERNAL EQUIPMENT (optional)

CODE	DESCRIPTION	DIMENSIONS (WxDxH) mm	RETENTION VOLUME (LITRES)	STORAGE CAPACITY*
CSF85P	Additional shelf made of stainless steel for basis compartment	536x420x39	7	30
CSF45P	Additional shelf made of painted steel for inflammable and toxics compartment	536x420x39	7	30
CSF65P	Additional shelf made of epoxy plasticated steel for acid compartment	536x420x39	7	30
S45S	Frame for pull-out shelf for CSF232/2C-3C-4C (shelf not included)			
CSF65SC	Additional sliding shelf made of plasticated steel for S45S	439x420x39	7	30
RIP85SC	Additional sliding shelf made of stainless steel for S45S	439x420x39	7	30
CSF45SC	Additional sliding shelf made of epoxy painted steel for S45S	439x420x39	7	30
P550SMY11	Groom with thermal fuse - left door	-	-	-
P550MY11	Groom with thermal fuse - right door	-	-	-
ZOCPAL120MY11	Base plate for pallet truck W1200	1200x600x110	-	-
CHEMIROLL	Wheel board to move the cabinets (the code ZOCPALMY11 is necessary)	-	-	-
AT100	Visual and audible alarm system with telephone transmission equipped with a digital thermostat with a T probe (°C) inside the cabinet	-	-	-
TIM24	Daily counter	-	-	-
ESTINTORE	Internal carbon dioxide fire-extinguisher with automatic thermal tripping (62 °C)	Ø 90x280	-	-

*Approximate capacity in bottles holding 1 litre

→ VENTILATION (optional)

CODE	DESCRIPTION	DIMENSIONS (WxDxH) mm
DIAM125BP	Fresh air box with filter holding box for high cabinet with 1 or 2 doors - outlet Ø: 125 mm (filter excluded)	290x290x270
CSF100BPAMY11	Fresh air box ATEX with power cable and filter box - outlet diam. 125 mm	350x370x500
RSOL	Activated charcoal filter (to replace at least twice a year)	235x110x15
GFKIT100	External connection kit (1 metre of hose diam 100 mm and 2 clamps)	Ø 100 - W 1000 mm
CFN	Fresh air box with molecular filtration according to standard NFX15-211, with visual and audible alarm	550x500x220
CFNL	Molecular filtration box manufactured, without alarm	550x500x220
CFNCO	Hour counter for CFN	
CSAS	Activated charcoal filter for solvents (prefilter included)	510x405x60
CSBE	Activated charcoal filter for acids (prefilter included)	510x405x60
CSMP	Activated charcoal filter for solvents and acids (prefilter included)	510x405x60
CSPF	Prefilter	510x405x15

*To obtain the complete list of the connection accessories, see the chapter on ventilation of this catalogue and the current price list



Series COMBISTORAGE 60 FIRE TYPE 90

Certified according to EN14470-1 & EN16121



CSF239/2C



CSF239/3C

The maximum safety
for all your products.
Partitioned cabinet completely
fire-resistant TYPE90

→ TECHNICAL FEATURES:

- Completely made of an electrogalvanized steel plate with a thickness from 1 to 1.5 mm, cold bent - Grey RAL7035
- External finishing made of acidproof epoxy resin and passage through a thermal tunnel at 200 °C
- Cabinet isolation through some high density rock wool panels and some calcium sulphate panels
- Internal finishing with melamine panels highly resistant to chemical and aggressive vapours
- Structure allowing replacing spare parts if necessary
- Automatic door closing when the ambient temperature exceeds 50 °C
- 30 mm thermo-expanding isolation seals that in case of temperature rise ensure a perfect cabinet sealing, according to standard EN14470-1
- Air inlet and outlet with certified fire dampers closing ducts when the temperature exceeds 70°C according to standard DIN 4102-6
- Prearrangement for ventilation through a Ø 100 mm flange for an external connection or a filtering ventilation system (see the chapter on ventilation)
- **Door closing and locking system allowing keeping the doors open** and closing them automatically if the ambient temperature is higher than 50 °C
- Spark resistant hinge ensuring a perfect door solidity
- Cabinet equipped with earthing

- Leveling jacks
- Door key lock
- Shelf made of painted steel or stainless steel whose height can be adjusted
- Shelf fastening on some aluminium eyelets excluding any spark risk
- Shelves tested to fire
- ISO 3864: Pictogram signalling
- Cabinets certified according to standards **EN14470-1** and **EN16121**

INTERNAL COMPARTMENTS to store various families of chemicals:

separation by means of panels made of HPL with a thickness of 18 mm coated with thermo-expanding seals (possibility of having up to 3 compartments and of customizing compartments - please contact us):

Compartment for «Inflammables»

- 1 retention shelf whose height can be adjusted and 1 retention tray with grid made of epoxy painted steel

Compartment for «Acids»

- 2 or 3 retention shelves whose height can be adjusted made of plasticated steel

Compartment for «Bases»

- 1 retention shelf whose height can be adjusted made of stainless steel

→ SERIES COMBISTORAGE FIRE 60 TYPE 90

CODE	DESCRIPTION	EXTERNAL DIMENSIONS (WxDxH) m	INTERNAL DIMENSIONS (WxDxH) mm	INTERNAL EQUIPMENT	STORAGE CAPACITY*	Weight Kg
CSF239/2C**	Cabinet series COMBISTORAGE T90 with 1 door - 2 compartments	595x600x1950	496x446x680+842	COMPARTMENT FOR INFLAMMABLES: 1 shelf made of painted steel + 1 retention tray with grid COMPARTMENT FOR ACIDS/BASES: 3 shelves made of plasticated steel (max load 60 Kg evenly distributed)	150	230
CSF239/3C**	Cabinet series COMBISTORAGE T90 with 1 door - 3 compartments	595x600x1950	496x446x680+842	COMPARTMENT FOR INFLAMMABLES: 1 shelf made of painted steel + 1 retention tray with grid COMPARTMENT FOR ACIDS: 2 shelves made of plasticated steel COMPARTMENT FOR BASES: 1 shelf made of stainless steel (max load 60 Kg evenly distributed)	150	232

*Approximate capacity in bottles holding 1 litre per cabinet

** Left door opening. Add « D » to the item code for the right door opening

→ INTERNAL EQUIPMENT (optional)

CODE	DESCRIPTION	DIMENSIONS (WxDxH) mm	RETENTION VOLUME (LITRES)	STORAGE CAPACITY*
RIP60VMY11	Additional shelf made of painted steel for inflammable compartment	493x420x39	7	30
RIP60MY11	Additional shelf made of stainless steel for inflammable compartment	493x420x39	7	30
RIP60MY11P	Additional shelf made of plasticated steel for acid compartment	493x420x39	7	30
S60S	Frame for pull-out shelf for FIRE 60 (shelf not included)			
RIP60VS	Additional sliding shelf made of painted steel for S60S	439x420x39	7	30
RIP60IS	Additional sliding shelf made of stainless steel for S60S	439x420x39	7	30
RIPGI	Additional rotating shelf for cabinet with 1 door			
PS50MY11	Replacement system with closing thermal fuse - left door	-	-	-
PS50MY11	Replacement system with closing thermal fuse - right door	-	-	-
ZOCPAL60MY11	Base plate for pallet truck W600	595x600x110	-	-
CHEMIROLL	Wheel board to move the cabinets (the code ZOCPALMY11 is necessary)	-	-	-
AT100	Visual and audible system with telephone transmission equipped with a digital thermostat with a T probe (°C) inside the cabinet			
TIM24	Daily counter	-	-	-
ESTINTORE	Internal carbon dioxide fire-extinguisher with automatic thermal tripping (62 °C)	Ø 90x280	-	-

*Approximate capacity in bottles holding 1 litre

→ VENTILATION (optional)

CODE	DESCRIPTION	DIMENSIONS (WxDxH) mm
DIAM125BP	Fresh air box with filter holding box for high cabinet with 1 or 2 doors - outlet Ø: 125 mm (filter excluded)	290x290x270
CSF100BPAMY11	Fresh air box ATEX with power cable and filter box - outlet diam. 125 mm	350x370x500
RSOL	Activated charcoal filter (to replace at least twice a year)	235x110x15
GFKIT100	External connection kit (1 metre of hose diam 100 mm and 2 clamps)	Ø 100 - W 1000 mm
CFN	Air fresh box with molecular filtration according to standard NFX15-211, with visual and audible alarm	550x500x220
CFNL	Molecular filtration box manufactured, without alarm	550x500x220
CFNCO	Hour counter for CFN	
CSAS	Activated charcoal filter for solvents (prefilter included)	510x405x60
CSBE	Activated charcoal filter for acids (prefilter included)	510x405x60
CSMP	Activated charcoal filter for solvents and acids (prefilter included)	510x405x60
CSPF	Prefilter	510x405x15

*To obtain the complete list of the connection accessories, see the chapter on ventilation of this catalogue and the current price list

TECHNICAL DRAWINGS

→ COMBISTORAGE UNDERBENCH FIRE TYPE 90

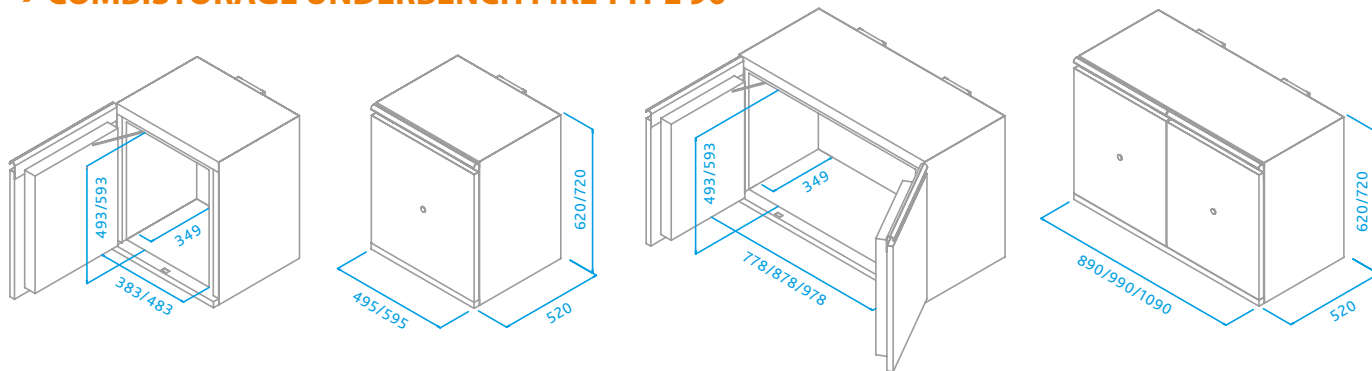

→ COMBISTORAGE UNDERBENCH CHEMICALS

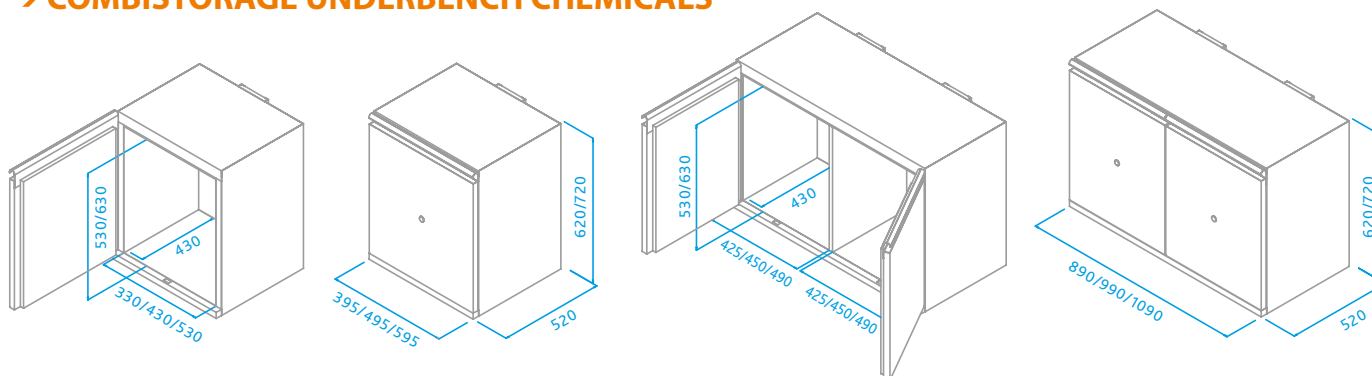

→ COMBISTORAGE UNDERBENCH - BACK



1

2

1 New closing system which allows to keep the doors open in any position. Automatic door closing in case the ambient temperature exceeds 50 °C

2 Ventilation system diam. 100 mm

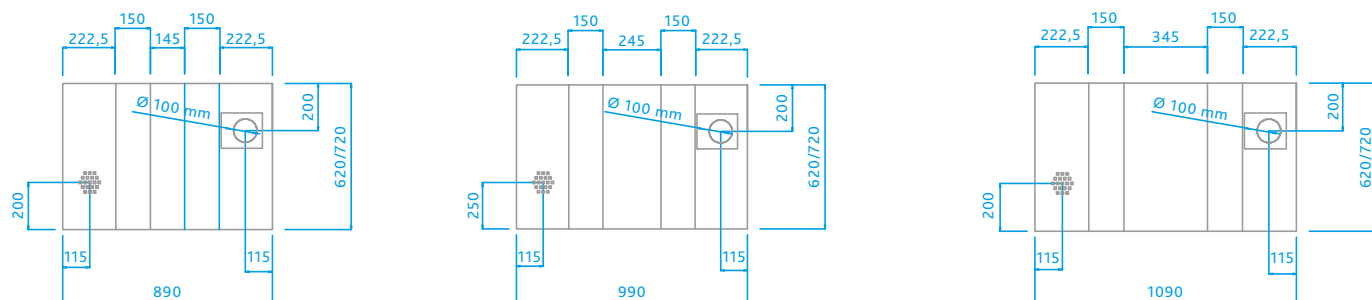
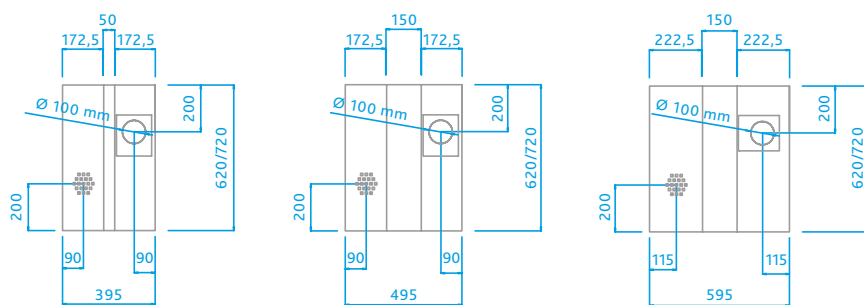

TECHNICAL DRAWINGS

→ FIREMY11/COMBISTORAGE/60/90/120

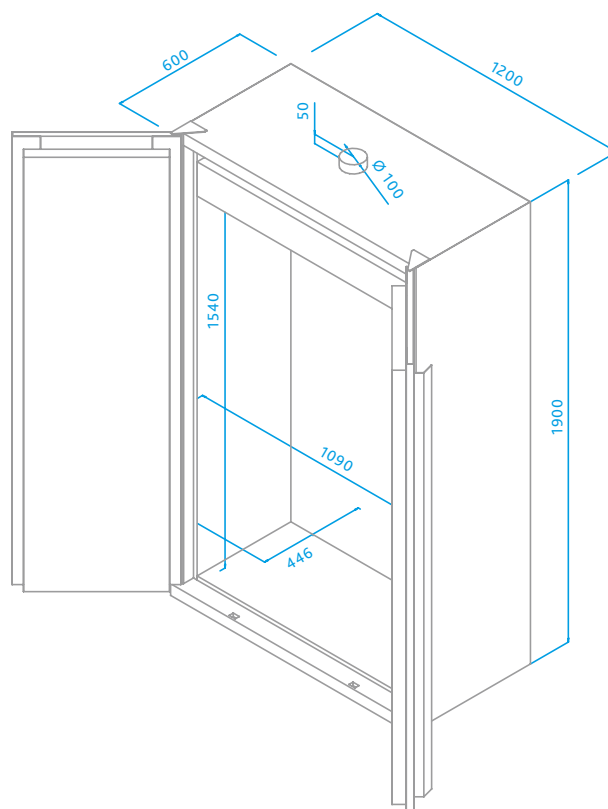
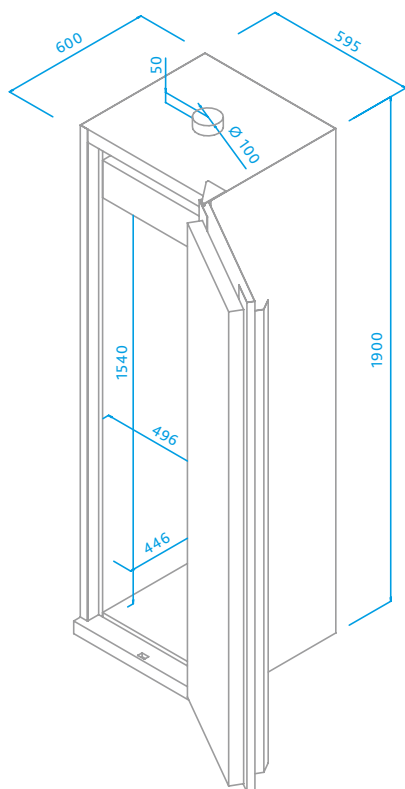

→ COMBISTORAGE 2C

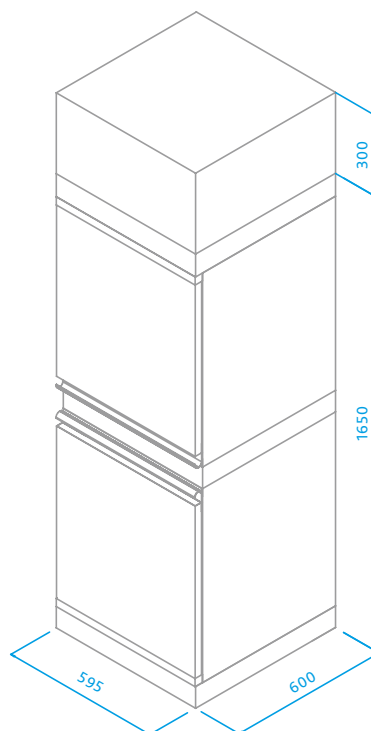
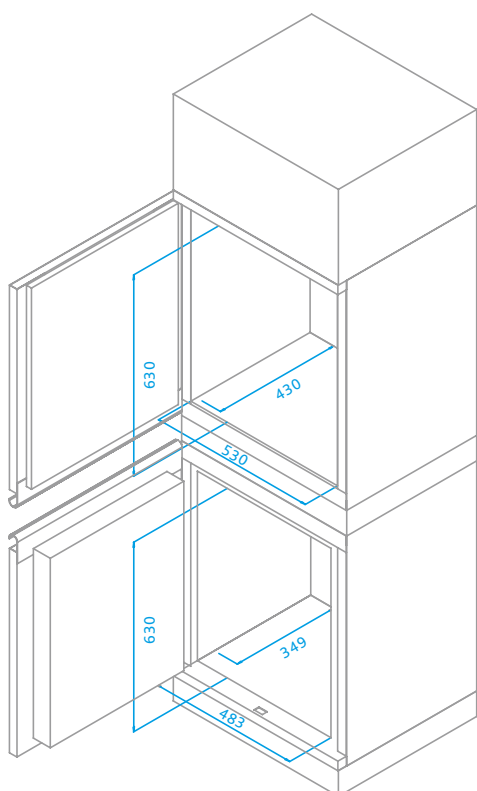

Series CHEMICALS

With fan and filter included
Plain and glazed doors

Certified according to EN61010-1;
EN16121 & CEI 66-5



CS106



CS103



CS106G



CS103G



CS104

These safety cabinets
solve the problem of storing
dangerous liquids

→ TECHNICAL FEATURES:

- Constructed in FE P01 grade, 10/10 thickness, electro-galvanized steel sheet (Skin passat) cold pressed and coated, following pre-treatment for removing grease, with an initial epoxy base application and two further thermo-hardening powder applications, oven-set at 200 °C
- "Monolithic" design, with adjustable feet at the base to allow the structure to be properly levelled
- "Sandwich-wall", reversible doors are constructed in the same materials and come complete with handles incorporating safety closures and locks
- CE marked, electro extraction fan with self-extinguishing polymer housing, which is antistatic and corrosion resistant
- Fuse protection: 5x20 mm, 1A quick blow
- Extraction fan capacity: 275 cu. m/h maximum
- Power supply: 220-230V 50Hz, single phase

- Rating: 55 W
- Top-mounted, activated carbon filter suitable for acidic substances, with pre-filter. Easy filter replacement behind a hinged panel with key-lock
- Handles fitted with lock and key
- 10/10 mm thick steel, tray-type shelves for retaining potential spilt liquid in the event of container breakage or leakage due to expansion of contents. Fully adjustable shelf height
- Doors open to 110° which allows internal shelves to be removed without having to incline them
- Multilingual safety signs indicate the presence of dangerous and toxic products to highlight contents and storage limitations
- Standardized pictograms according to standards ISO 3864
- Key lock
- Complying with standards EN61010-1; EN16121 & CEI 66-5

→ SERIES CHEMICALS

CODE	DESCRIPTION	EXTERNAL DIMENSIONS (WxDxH) mm	INTERNAL DIMENSIONS (WxDxH) mm	INTERNAL EQUIPMENT	STORAGE CAPACITY*	Weight (Kg)
CS103	Cabinet with 1 door left handle	600x600x1900 (1600+300)	550x550x1500	3 plasticated shelves (max load 40 Kg evenly distributed)	75	80
CS103G	Cabinet with 1 glazed door left handle	600x600x1900 (1600+300)	550x550x1500	3 plasticated shelves (max load 40 Kg evenly distributed)	75	80
CS104	Cabinet with 2 doors 2 compartments left handle	600x600x1900 (1600+300)	550x550x1500	Upper compartment: 2 plasticated steel full-width shelves for acids; Bottom compartment: 2 stainless steel full-width shelves for bases	100	85
CS104G	Cabinet with 2 glazed doors 2 compartments left handle	600x600x1900 (1600+300)	550x550x1500	Upper compartment: 2 plasticated steel full-width shelves for acids; Bottom compartment: 2 stainless steel full-width shelves for bases	100	85
CS106	Cabinet with 2 doors	1140x600x1900 (1600+300)	1080x550x1500	3 plasticated shelves (max load 80 Kg evenly distributed)	100	125
CS106G	Cabinet with 2 glazed doors	1140x600x1900 (1600+300)	1080x550x1500	3 plasticated shelves (max load 80 Kg evenly distributed)	100	125

*Approximate capacity in bottles holding 1 litre per cabinet

→ INTERNAL EQUIPMENT (optional)

CODE	DESCRIPTION	DIMENSIONS (WxDxH) mm	RETENTION VOLUME (LITRES)	STORAGE CAPACITY*
RIPCS60	Additional fixed shelf made of plasticated steel for cabinet with 1 door	485x545x30	9	35
RIPCS120	Additional fixed shelf made of plasticated steel for cabinet with 2 doors	1025x545x30	19	70
RIPX60	Additional fixed shelf made of stainless steel for cabinet with 1 door	485x545x30	9	35
RIPX120	Additional fixed shelf made of stainless steel for cabinet with 2 doors	1025x545x30	19	70
DIV120	Central division for cabinet CS106 and CS106G - with 2 doors	-	-	-
RIP60SC	«Sliding shelf»: Sliding system to be added to the shelf (only for cabinet with 1 door or cabinet with 2 compartments)	-	-	-
RIP60PI	Additional shelf made of polypropylene (on request) for cabinet with 1 door			
RIP120PI	Additional shelf made of polypropylene (on request) for cabinet with 2 door			
ZOCPALCS60	Palletized plinth for CS 60			
ZOCPALCS120	Palletized plinth for CS 120			
VACS60	Additional retention tray made of plasticated steel for cabinet with 1 door	485x545x70	18	35
VACS120	Additional retention tray made of plasticated steel for cabinet with 2 doors	1025x545x70	39	70
VA60PP	Additional retention tray made of polypropylene for cabinet with 1 door	485x545x70	18	35
VA120PP	Additional retention tray made of polypropylene for cabinet with 2 doors	1025x545x70	39	70
TIM24	Daily counter	-	-	-
ALLARME	Alarm system for «open doors»	-	-	-

*Approximate capacity in bottles holding 1 litre

→ VENTILATION (optional)

CODE	DESCRIPTION	DIMENSIONS (WxDxH) mm
2CP104	Fresh air box with panelling for cabinet with 1 door - connecting Ø 125 mm	600x600x300
2CP106	Fresh air box with panelling for cabinet with 2 doors - connecting Ø 125 mm	1140x600x300
DIAM125BP	Fresh air box with filter holding box for high cabinet with 1 or 2 doors - outlet Ø: 125 mm (filter excluded)	290x290x270
RSOLCA	Activated charcoal filter for motor DIAM125BP - (to replace at least twice a year)	235x110x15
RE1000	Fan flow controller (to be ordered with the fan DIAM125BP)	-
GFKIT125	Connection kit: 1 metre of flexible sheath Ø 125 mm and 2 clamps	Ø 125 mm
CFN	Fresh air box with molecular filtration according to standard NFX15-211, with visual and audible alarm	550x500x220
CFNL	Molecular filtration box manufactured, without alarm	550x500x220
CFNCO	Hour counter for CFN	
CSAS	Activated charcoal filter for solvents (prefilter included)	510x405x60
CSBE	Activated charcoal filter for acids (prefilter included)	510x405x60
CSMP	Activated charcoal filter for solvents and acids (prefilter included)	510x405x60
CSPF	Prefilter	510x405x15
RFC60	Filter for 60 Basic (spare part for CS60 and CS60A+B)	
RFC120	Filter for 120 Basic (spare part for CS120)	

*To obtain the complete list of the connection accessories, see the chapter on ventilation of this catalogue and the current price list

Series CHEMICALS BASIC

Plain and glazed doors

Certified according to EN61010-1;
EN16121 & CEI 66-5



CS102G



CS102



CS105



CS105G

These safety cabinets
solve the problem of storing
dangerous liquids

→ TECHNICAL FEATURES:

- Constructed in FE P01 grade, 10/10 thickness, electro-galvanized steel sheet (Skin passat) cold pressed and coated, following pre-treatment for removing grease, with an initial epoxy base application and two further thermo-hardening powder applications, oven-set at 200 °C
- "Monolithic" design, with adjustable feet at the base to allow the structure to be properly levelled
- "Sandwich-wall", reversible doors are constructed in the same materials and come complete with handles incorporating safety closures and locks
- Top-mounted, activated carbon filter (optional) suitable for acidic substances, with pre-filter. Easy filter replacement behind a hinged panel with key-lock
- Handles fitted with lock and key
- 10/10 mm thick steel, tray-type shelves for retaining potential spilt liquid in the event of container breakage or leakage due to expansion of contents. Fully adjustable shelf height
- Doors open to 110° which allows internal shelves to be removed without having to incline them
- Multilingual safety signs indicate the presence of dangerous and toxic products to highlight contents and storage limitations
- Standardized pictograms according to standards ISO 3864
- Key lock
- Complying with standards EN61010-1; EN16121 & CEI 66-5

→ SERIES CHEMICALS BASIC

CODE	DESCRIPTION	EXTERNAL DIMENSIONS (WxDxH) mm	INTERNAL DIMENSIONS (WxDxH) mm	INTERNAL EQUIPMENT	STORAGE CAPACITY*	Weight (Kg)
CS102	Cabinet with 1 door left handle	600x600x1600	550x550x1500	3 plasticated shelves (max load 40 Kg evenly distributed)	75	70
CS102G	Cabinet with 1 glazed door left handle	600x600x1600	550x550x1500	3 plasticated shelves (max load 40 Kg evenly distributed)	75	75
CS105	Cabinet with 2 doors	1140x600x1600	1080x550x1500	3 plasticated shelves (max load 80 Kg evenly distributed)	100	110
CS105G	Cabinet with 2 glazed doors	1140x600x1600	1080x550x1500	3 plasticated shelves (max load 80 Kg evenly distributed)	100	115

*Approximate capacity in bottles holding 1 litre per cabinet

→ INTERNAL EQUIPMENT (optional)

CODE	DESCRIPTION	DIMENSIONS (WxDxH) mm	RETENTION VOLUME (LITRES)	STORAGE CAPACITY*
RIPCS60	Additional fixed shelf made of plasticated steel for cabinet with 1 door	485x545x30	9	35
RIPCS120	Additional fixed shelf made of plasticated steel for cabinet with 2 doors	1025x545x30	19	70
RIPX60	Additional fixed shelf made of stainless steel for cabinet with 1 door	485x545x30	9	35
RIPX120	Additional fixed shelf made of stainless steel for cabinet with 2 doors	1025x545x30	19	70
DIV120	Central division for cabinet CS106 and CS106G - with 2 doors	-	-	-
RIP60SC	«Sliding shelf»: Sliding system to be added to the shelf (only for cabinet with 1 door or cabinet with 2 compartments)	-	-	-
RIP60PI	Additional shelf made of polypropylene (on request) for cabinet with 1 door			
RIP120PI	Additional shelf made of polypropylene (on request) for cabinet with 2 door			
ZOCPALCS60	Palletized plinth for CS 60			
ZOCPALCS120	Palletized plinth for CS 120			
VACS60	Additional retention tray made of plasticated steel for cabinet with 1 door	485x545x70	18	35
VACS120	Additional retention tray made of plasticated steel for cabinet with 2 doors	1025x545x70	39	70
VA60PP	Additional retention tray made of polypropylene for cabinet with 1 door	485x545x70	18	35
VA120PP	Additional retention tray made of polypropylene for cabinet with 2 doors	1025x545x70	39	70
TIM24	Daily counter	-	-	-
ALLARME	Alarm system for «open doors»	-	-	-

*Approximate capacity in bottles holding 1 litre

→ VENTILATION (optional)

CODE	DESCRIPTION	DIMENSIONS (WxDxH) mm
2CP104	Fresh air box with panelling for cabinet with 1 door - connecting Ø 125 mm	600x600x300
2CP106	Fresh air box with panelling for cabinet with 2 doors - connecting Ø 125 mm	1140x600x300
DIAM125BP	Fresh air box with filter holding box for high cabinet with 1 or 2 doors - outlet Ø: 125 mm (filter excluded)	290x290x270
RSOLCA	Activated charcoal filter for motor DIAM125BP - (to replace at least twice a year)	235x110x15
RE1000	Fan flow controller (to be ordered with the fan DIAM125BP)	-
GFKIT125	Connection kit: 1 metre of flexible sheath Ø 125 mm and 2 clamps	Ø 125 mm
CFN	Fresh air box with molecular filtration according to standard NFX15-211, with visual and audible alarm	550x500x220
CFNL	Molecular filtration box manufactured, without alarm	550x500x220
CFNCO	Hour counter for CFN	
CSAS	Activated charcoal filter for solvents (prefilter included)	510x405x60
CSBE	Activated charcoal filter for acids (prefilter included)	510x405x60
CSMP	Activated charcoal filter for solvents and acids (prefilter included)	510x405x60
CSPF	Prefilter	510x405x15
RFC60	Filter for 60 Basic (spare part for CS60 and CS60A+B)	
RFC120	Filter for 120 Basic (spare part for CS120)	

*To obtain the complete list of the connection accessories, see the chapter on ventilation of this catalogue and the current price list

Series High density PVC

Plain doors



Certified according to EN 61010-1



CS102PVC



CS103PVC



CS104BPVC



CS104PVC



CS105PVC



CS106PVC



CS101PVC



CS100PVC

It is ideal for storing very aggressive chemicals

→ TECHNICAL FEATURES:

- Completely manufactured from 18 mm thickness of PVC HD
- Cover fan and plinth completely manufactured from 1,0 mm thickness steel sheet, cold pressed, epoxy coated with acid resistant epoxy powders electro-statically applied at a temperature of 200 °C, which ensures a layer thickness higher than 90 microns on the whole surface of the cabinet
- One- piece structure built on a 15/10 mm plinth with leveling jacks
- Division in 2, 3 or 4 compartments for storing separately the different families of not flammable chemical products
- Single- wall hinged plain doors
- Key lock
- Door opening with an angle of 110° allowing extracting the shelves without tilting them
- External hinge made of plastic resistant to corrosion
- Compartments equipped with retention shelves made in PVC whose height can be adjusted
- Ø 125 mm connection collar
- Available with or without ventilation unit
- Modular solutions
- Basin form shelf
- Standardized pictograms according to standards ISO 3864
- **Complying with standards EN 61010-1**

→ SERIES Hight density PVC

CODE	DESCRIPTION	EXTERNAL DIMENSIONS (WxDxH) mm	INTERNAL DIMENSIONS (WxDxH) mm	INTERNAL EQUIPMENT	STORAGE CAPACITY*	Weight (Kg)
CS102PVC	Cabinet with 1 door - 1 compartment	600x600x1600	562x562x1470	3 PVC shelves (max load 40 Kg evenly distributed)	75	77
CS103PVC	Cabinet with 1 door - 1 compartment Fan and filter included	600x600x1900	562x562x1470	3 PVC shelves (max load 40 Kg evenly distributed)	75	85
CS104BPVC	Cabinet with 2 doors 2 compartments stacked one on top of the other	600x600x1600	562x562x1470	2 PVC shelves per compartment (max load 40 Kg evenly distributed)	100	78
CS104PVC	Cabinet with 2 doors 2 compartments stacked one on top of the other Fan and filter included	600x600x1900	562x562x1470	2 PVC shelves per compartment (max load 40 Kg evenly distributed)	100	86
CS105PVC	Cabinet with 2 doors 2 compartments (vertical partition wall)	1140x600x1600	1102x562x1470	3 PVC shelves per compartment (max load 40 Kg evenly distributed)	150	87
CS106PVC	Cabinet with 2 doors 2 compartments (vertical partition wall) Fan and filter included	1140x600x1900	1102x562x1470	3 PVC shelves per compartment (max load 40 Kg evenly distributed)	150	99
CS101PVC	Underbench cabinet with 1 door	600x500x790	562x462x686	2 PVC shelves (max load 40 Kg evenly distributed)	50	32
CS100PVC	Underbench cabinet with 2 doors 2 compartments	1140x500x790	1102x462x686	2 PVC shelves per compartment (max load 40 Kg evenly distributed)	100	43

*Approximate capacity in bottles holding 1 litre per cabinet

→ INTERNAL EQUIPMENT (optional)

CODE	DESCRIPTION	DIMENSIONS (WxDxH) mm	RETENTION VOLUME (LITRES)	STORAGE CAPACITY*
WLRIP6060	Additional shelf in PVC	550x530x30	9	25
WLRIP60UB	Additional shelf in PVC for UB PVC	537x434x30	7	25
TIM24	Daily counter	-	-	-
ALLARME	Alarm system for «open doors»	-	-	-

*Approximate capacity in bottles holding 1 litre

→ VENTILATION (optional)

CODE	DESCRIPTION	DIMENSIONS (WxDxH) mm
DIAM125BP	Fresh air box with filter holding box for high cabinet with 1 or 2 doors- outlet Ø 125 mm (filter excluded)	290x290x270
RSOLCA	Activated charcoal filter for motor DIAM125BP - (to replace at least twice a year)	235x110x15
F125C	Duct connector Ø 125 mm for underbench cabinets	Ø 125 mm
RE1000	Fan flow controller (to be ordered with the fan DIAM125BP)	-
GFKIT125	Connection kit: 1 metre of flexible sheath Ø 125 mm and 2 clamps	Ø 125 mm
RFC560	Spare filter for 600 mm exhausted cabinet	
RFC5120	Spare filter for 1140 mm exhausted cabinet	

*To obtain the complete list of the connection accessories, see the chapter on ventilation of this catalogue and the current price list

Series WOODLINE

With fan and filter included
Plain doors

**Certified according to EN61010-1;
EN16121 & CEI 66-5**



✓
Panels made of HPL
resistant to corrosion



CS106W



CS103W



CS104W

→ TECHNICAL FEATURES:

- Cabinet body made of waterproof agglomerate coated with plastic melamine HPL fireproof F1 with rounded edges Grey RAL7035
- Removable construction with leveling jacks on a metal base plate
- Metal parts (hinges, clips, guides) painted against corrosion
- Door opening with an angle higher than 110°
- Key lock
- Two separate compartments (on cabinets with two doors)
- High cabinets equipped with 2 fixed retention shelves made of PVC per compartment, whose height can be adjusted
- Underbench cabinets equipped with two removable drawers with retention tray made of polypropylene (fixed with velcro), per compartment
- Underbench cabinets placed on a metal base plate with a height of 60 mm
- Max load per shelf: 40 Kg evenly distributed
- Cushioning system of doors and drawers
- Ø 125 mm connection collar
- Standardized pictograms according to standards ISO 3864
- **Complying with standards EN61010-1 EN16121 & CEI 66-5**

→ SERIES WOODLINE

CODE	DESCRIPTION	EXTERNAL DIMENSIONS (WxDxH) mm	INTERNAL DIMENSIONS (WxDxH) mm	INTERNAL EQUIPMENT	STORAGE CAPACITY*	Weight (Kg)
CS103W	Cabinet with 1 door left handle	600x600x1900 (1600+300)	550x550x1500	3 shelves made of PVC (charge max 40 Kg evenly distributed)	75	85
CS104W	Cabinet with 2 doors 2 compartments left handle	600x600x1900 (1600+300)	550x580x1500	Upper compartment: 2 shelves made of PVC full-width shelves for acids; Bottom compartment: 2 shelves made of PVC full-width shelves for bases	100	86
CS106W	Cabinet with 2 doors	1140x600x1900 +60 (base plate)	1090x580x1500	2 shelves made of PVC per compartment (max load 40 Kg evenly distributed)	100	99

*Approximate capacity in bottles holding 1 litre per cabinet

→ INTERNAL EQUIPMENT (optional)

CODE	DESCRIPTION	DIMENSIONS (WxDxH) mm	RETENTION VOLUME (LITRES)	STORAGE CAPACITY*
WLRIP6060	Additional fixed shelf made of PVC for high cabinet with 1 or 2 doors	550x530x30	9	20
RIPWPP	Additional shelf made of PP for cabinet 60 UB W and 120 UB W	490x410x48	7	15
TIM24	Daily counter	-	-	-

*Approximate capacity in bottles holding 1 litre

→ VENTILATION (optional)

CODE	DESCRIPTION	DIMENSIONS (WxDxH) mm
DIAM125BP	Fresh air box with filter holding box for high cabinet with 1 or 2 doors - outlet Ø 125 mm (filter excluded)	290x290x270
RSOLCA	Activated charcoal filter for motor DIAM125BP - (to replace at least twice a year)	235x110x15
RE1000	Fan flow controller (to be ordered with the fan DIAM125BP)	-
GFKIT125	Connection kit: 1 metre of flexible sheath Ø 125 mm and 2 clamps	Ø 125 mm
CFN	Fresh air box with molecular filtration according to standard NFX15-211	550x500x220
CFNL	Molecular filtration box manufactured, without alarm	550x500x220
CFNCO	Hour counter for CFN	
CFNUB	Fresh air box certified according to standard NFX15-211 for underbench cabinets, equipped with wheels, 2 ventilation outlets	400x500x650
CFNUBL	Fresh air box for underbench cabinets, equipped with wheels, 2 ventilation outlets without alarm	400x500x650
CSAS	Activated charcoal filter for solvents (prefilter included)	510x405x60
CSBE	Activated charcoal filter for acids (prefilter included)	510x405x60
CSMP	Activated charcoal filter for solvents and acids (prefilter included)	510x405x60
CSPF	Prefilter	510x405x15
RFC60	Filter for 60 Basic (spare part for CS60 and CS60A+B)	
RFC120	Filter for 120 Basic (spare part for CS120)	

*To obtain the complete list of the connection accessories, see the chapter on ventilation of this catalogue and the current price list



Series WOODLINE BASIC

Plain doors



✓
Panels made of HPL
resistant to corrosion

Certified according to EN61010-1; EN16121 & CEI 66-5



CS102W



CS105W



Door cushioning system



Sliding shelves made of PP
(underbench cabinet)



CS101W



CS100W CLOSED



CS100W OPEN

→ TECHNICAL FEATURES:

- Cabinet body made of waterproof agglomerate coated with plastic melamine HPL fireproof F1 with rounded edges Grey RAL7035
- Removable construction with leveling jacks on a metal base plate
- Metal parts (hinges, clips, guides) painted against corrosion
- Door opening with an angle higher than 110°
- Key lock
- Two separate compartments (on cabinets with two doors)
- High cabinets equipped with 2 fixed retention shelves made of PVC per compartment, whose height can be adjusted
- Underbench cabinets equipped with two removable drawers with retention tray made of polypropylene (fixed with velcro), per compartment
- Underbench cabinets placed on a metal base plate with a height of 60 mm
- Max load per shelf: 40 Kg evenly distributed
- Cushioning system of doors and drawers
- Ø 125 mm connection collar
- Standardized pictograms according to standards ISO 3864
- **Complying with standards EN61010-1 EN16121 & CEI 66-5**

→ SERIES WOODLINE BASIC

CODE	DESCRIPTION	EXTERNAL DIMENSIONS (WxDxH) mm	INTERNAL DIMENSIONS (WxDxH) mm	INTERNAL EQUIPMENT	STORAGE CAPACITY*	Weight (Kg)
CS102W	Cabinet with 1 door left handle	600x600x1600	550x580x1500	2 shelves made of PVC (charge max 40 Kg evenly distributed)	75	85
CS105W	Cabinet with 2 doors 2 compartments	1140x600x1600	1090x580x1500	2 shelves made of PVC per compartment (max load 40 Kg evenly distributed)	100	120
CS101W	Underbench Cabinet with 1 door left handle	560x500x640 +60 (base plate)	540x480x580	2 removable drawers with retention tray made of PP (max load 40 Kg evenly distributed)	40	39
CS100W	Underbench cabinet with 2 doors - 2 compartments	1120x500x640 +60 (base plate)	1070x480x580	2 removable drawers with retention tray made of PP per compartment (max load 40 Kg evenly distributed)	80	73

*Approximate capacity in bottles holding 1 litre per cabinet

→ INTERNAL EQUIPMENT (optional)

CODE	DESCRIPTION	DIMENSIONS (WxDxH) mm	RETENTION VOLUME (LITRES)	STORAGE CAPACITY*
WLIP6060	Additional fixed shelf made of PVC for high cabinet with 1 or 2 doors	550x530x30	9	20
RIPWPP	Additional shelf made of PP for cabinet 60 UB W and 120 UB W	490x410x48	7	15
TIM24	Daily counter	-	-	-

*Approximate capacity in bottles holding 1 litre

→ VENTILATION (optional)

CODE	DESCRIPTION	DIMENSIONS (WxDxH) mm
DIAM125BP	Fresh air box with filter holding box for high cabinet with 1 or 2 doors - outlet Ø 125 mm (filter excluded)	290x290x270
RSOLCA	Activated charcoal filter for motor DIAM125BP - (to replace at least twice a year)	235x110x15
RE1000	Fan flow controller (to be ordered with the fan DIAM125BP)	-
GFKIT125	Connection kit: 1 metre of flexible sheath Ø 125 mm and 2 clamps	Ø 125 mm
CFN	Fresh air box with molecular filtration according to standard NFX15-211	550x500x220
CFNL	Molecular filtration box manufactured, without alarm	550x500x220
CFNCO	Hour counter for CFN	
CFNUB	Fresh air box certified according to standard NFX15-211 for underbench cabinets, equipped with wheels, 2 ventilation outlets	400x500x650
CFNUBL	Fresh air box for underbench cabinets, equipped with wheels, 2 ventilation outlets without alarm	400x500x650
CSAS	Activated charcoal filter for solvents (prefilter included)	510x405x60
CSBE	Activated charcoal filter for acids (prefilter included)	510x405x60
CSMP	Activated charcoal filter for solvents and acids (prefilter included)	510x405x60
CSPF	Prefilter	510x405x15
RFC560	Filter for 60 Basic (spare part for CS60 and CS60A+B)	
RFC120	Filter for 120 Basic (spare part for CS120)	

*To obtain the complete list of the connection accessories, see the chapter on ventilation of this catalogue and the current price list

Series CS Plain doors

Certified according to EN61010-1; EN16121 & CEI 66-5



CS106P



CS104P/4C



CS103PS
with additional shelves
RIPCS60+RIP60SC



CS103P



CS104P/2C



CS104P/3C

The certified solution
for storing all your
families of chemicals

→ TECHNICAL FEATURES:

- Completely made of an electrogalvanized steel plate with a thickness of 10/10 mm, cold bent - Grey RAL7035
- External finishing made of acidproof epoxy resin and passage through a thermal tunnel at 200 °C
- Construction in one piece with jacks to level the cabinet
- Plain swing doors or with **double wall**
- Key lock
- Door opening with an angle of 110° allowing extracting shelves without tilting them
- Equipped with fixed retention shelves made of plasticated/painted/stainless steel, whose height can be adjusted
- Possibility of having some **sliding shelves** with W600 mm
- Possibility of having a retention tray on the cabinet bottom (see the table below)
- Ø 125 mm connection collar
- Standardized pictograms according to standards ISO 3864
- **Complying with standards EN61010-1; EN16121 & CEI 66-5**

→ SERIES CS PLAIN DOORS

CODE	DESCRIPTION	EXTERNAL DIMENSIONS (WxDxH) mm	INTERNAL DIMENSIONS (WxDxH) mm	EQUIPEMENTS INTERNES	STORAGE CAPACITY*	Weight Kg
FIXED SHELVES						
CS103P	Cabinet 1 door - Left handle	600x600x1950	595x567x1864	3 shelves made of plasticated steel (max load 40 Kg evenly distributed)	100	78
CS106P	Cabinet 2 doors - 1 compartment	1140x600x1950	1025x567x1864	3 shelves made of plasticated steel (max load 80 Kg evenly distributed)	200	115
CS104P/2C	Cabinet COMBICHEM 2C - 2 doors 2 superimposed compartments	600x600x1950	595x567x930+930	2 shelves made of plasticated steel + 2 shelves made of stainless steel (max load 40 Kg evenly distributed)	140	110
CS104P/3C	Cabinet COMBICHEM 3C - 3 doors 3 superimposed compartments	600x600x1950	595x567x618+618+618	2 shelves made of plasticated steel +2 shelves made of painted steel + 2 shelves made of stainless steel (max load 40 Kg evenly distributed)	210	115
CS104P/4C	Cabinet COMBICHEM 4C 4 doors – 4 compartments (2+2)	1140x600x1950	568+568x567x930+930	6 shelves made of plasticated steel + 2 shelves made of stainless steel (max load 40 Kg evenly distributed)	280	140
SLIDING SHELVES						
CS103PS	Cabinet with 1 door Left handle	600x600x1950	595x567x1864	3 shelves made of plasticated steel (max load 40 Kg evenly distributed)	100	80
CS106PS	Cabinet with 2 doors 2 compartments	1140x600x1950	503+503x567x1864	3 shelves made of plasticated steel per compartment (max load 40 Kg evenly distributed)	200	130

*Approximate capacity in bottles holding 1 litre per cabinet

→ INTERNAL EQUIPMENT (optional)

CODE	DESCRIPTION	DIMENSIONS (WxDxH) mm	RETENTION VOLUME (LITRES)	STORAGE CAPACITY*
RIPCS60	Additional fixed shelf made of plasticated steel for cabinet with 1 door	485x545x30	9	35
RIPCS120	Additional fixed shelf made of plasticated steel for cabinet with 2 doors	1025x545x30	19	70
RIPX60	Additional fixed shelf made of stainless steel for cabinet with 1 door	485x545x30	9	35
RIPX120	Additional fixed shelf made of stainless steel for cabinet with 2 doors	1025x545x30	19	70
DIVECO120	Central division for PLUS cabinet with 2 doors	-	-	-
RIP60SC	«Sliding shelf»: Sliding system to be added to the shelf (only for cabinet with 1 door or cabinet with 2 compartments)	-	-	-
RIP60PI	Additional shelf made of polypropylene (on request) for cabinet with 1 door			
RIP120PI	Additional shelf made of polypropylene (on request) for cabinet with 2 door			
VACS60	Additional retention tray made of plasticated steel for cabinet with 1 door	485x545x70	18	35
VACS120	Additional retention tray made of plasticated steel for cabinet with 2 doors	1025x545x70	39	70
VA60PP	Additional retention tray made of polypropylene for cabinet with 1 door	485x545x70	18	35
VA120PP	Additional retention tray made of polypropylene for cabinet with 2 doors	1025x545x70	39	70
TIM24	Daily counter	-	-	-
ALLARME	Alarm system for «open doors»	-	-	-

*Approximate capacity in bottles holding 1 litre

→ VENTILATION (optional)

CODE	DESCRIPTION	DIMENSIONS (WxDxH) mm
2CP104	Fresh air box with panelling for cabinet with 1 door - connecting Ø 125 mm	600x600x300
2CP106	Fresh air box with panelling for cabinet with 2 doors - connecting Ø 125 mm	1140x600x300
DIAM125BP	Fresh air box with filter holding box for high cabinet with 1 or 2 doors - outlet Ø 125 mm (filter excluded)	290x290x270
RSOLCA	Activated charcoal filter for motor DIAM125BP - (to replace at least twice a year)	235x110x15
RE1000	Fan flow controller (to be ordered with the fan DIAM125BP)	-
GFKIT125	Connection kit: 1 metre of flexible sheath Ø 125 mm and 2 clamps	Ø 125 mm
CFN	Fresh air box with molecular filtration according to standard NFX15-211, with visual and audible alarm	550x500x220
CFNL	Molecular filtration box manufactured, without alarm	550x500x220
CFNCO	Hour counter for CFN	
CSAS	Activated charcoal filter for solvents (prefilter included)	510x405x60
CSBE	Activated charcoal filter for acids (prefilter included)	510x405x60
CSMP	Activated charcoal filter for solvents and acids (prefilter included)	510x405x60
CSPF	Prefilter	510x405x15
RFC60	Filter for 60 Basic (spare part for CS60 and CS60A+B)	
RFC120	Filter for 120 Basic (spare part for CS120)	

*To obtain the complete list of the connection accessories, see the chapter on ventilation of this catalogue and the current price list

Series CS Glazed doors

Certified according to EN61010-1; EN16121 & CEI 66-5



CS106PG



CS104PG/4C



CS103PGS
with additional shelves
RIPCS60+RIP60SC



CS103PG



CS104PG/2C



CS104PG/3C

The certified solution
for storing your families
of chemicals

→ TECHNICAL FEATURES:

- Completely made of an electrogalvanized steel plate with a thickness of 10/10 mm, cold bent - Grey RAL7035
- External finishing made of acidproof epoxy resin and passage through a thermal tunnel at 200 °C
- Construction in one piece with leveling jacks
- Possibility of having 1, 2, 3 or 4 compartments for storing separately the different families of nonflammable chemical products
- Glazed swing doors with **double wall**
- Key lock

- Door opening with an angle of 110° allowing extracting the shelves without tilting them
- Equipped with fixed or sliding retention shelves made of plasticated/painted/stainless steel, whose height can be adjusted
- Possibility of having a retention ray on the cabinet bottom (see the table below)
- Ø 125 mm connection collar
- Standardized pictograms according to standards ISO 3864
- **Complying with standards EN61010-1; EN16121 & CEI 66-5**
- Complying with articles 5162 and 5170 of the Public Health Code

→ SERIES CS GLAZED DOORS

CODE	DESCRIPTION	EXTERNAL DIMENSIONS (WxDxH) mm	INTERNAL DIMENSIONS (WxDxH) mm	INTERNAL EQUIPMENT	STORAGE CAPACITY*	Weight Kg
FIXED SHELVES						
CS103PG	Cabinet with 1 door - Left handle	600x600x1950	595x567x1864	3 shelves made of plasticated steel (max load 40 Kg evenly distributed)	100	78
CS106PG	Cabinet with 2 doors - 1 compartment	1140x600x1950	1025x567x1864	3 shelves made of plasticated steel (max load 80 Kg evenly distributed)	200	115
CS104PG/2C	Cabinet COMBICHEM 2C Cabinet with 2 doors 2 superimposed compartments	600x600x1950	595x567x930+930	2 shelves made of plasticated steel + 2 shelves made of stainless steel (max load 40 Kg evenly distributed)	140	110
CS104PG/3C	Cabinet COMBICHEM 3C Cabinet with 3 doors 3 superimposed compartments	600x600x1950	595x567x618+618+618	2 shelves made of plasticated steel + 2 shelves made of painted steel + 2 shelves made of stainless steel (max load 40 Kg evenly distributed)	210	115
CS104PG/4C	Cabinet COMBICHEM 4C - Cabinet with 4 doors - 4 compartments (2+2)	1140x600x1950	568+568x567x930+930	6 shelves made of painted steel + 2 shelves made of plasticated steel (max load 40 Kg evenly distributed)	280	140
SLIDING SHELVES						
CS103PGS	Cabinet with 1 door Left handle	600x600x1950	595x567x1864	3 shelves made of painted steel (max load 40 Kg evenly distributed)	100	80
CS106PGS	Cabinet with 2 doors 2 compartments	1140x600x1950	503+503x567x1864	3 shelves made of painted steel per compartment (max load 40 Kg evenly distributed)	200	130

*Approximate capacity in bottles holding 1 litre per cabinet

→ INTERNAL EQUIPMENT (optional)

CODE	DESCRIPTION	DIMENSIONS (WxDxH) mm	RETENTION VOLUME (LITRES)	STORAGE CAPACITY*
RIPCS60	Additional fixed shelf made of plasticated steel for cabinet with 1 door	485x545x30	9	35
RIPCS120	Additional fixed shelf made of plasticated steel for cabinet with 2 doors	1025x545x30	19	70
RIPX60	Additional fixed shelf made of stainless steel for cabinet with 1 door	485x545x30	9	35
RIPX120	Additional fixed shelf made of stainless steel for cabinet with 2 doors	1025x545x30	19	70
DIVECO120	Central division for PLUS cabinet with 2 doors	-	-	-
RIP60SC	«Sliding shelf»: Sliding system to be added to the shelf (only for cabinet with 1 door or cabinet with 2 compartments)	-	-	-
RIP60PI	Additional shelf made of polypropylene (on request) for cabinet with 1 door			
RIP120PI	Additional shelf made of polypropylene (on request) for cabinet with 2 door			
VACS60	Additional retention tray made of plasticated steel for cabinet with 1 door	485x545x70	18	35
VACS120	Additional retention tray made of plasticated steel for cabinet with 2 doors	1025x545x70	39	70
VA60PP	Additional retention tray made of polypropylene for cabinet with 1 door	485x545x70	18	35
VA120PP	Additional retention tray made of polypropylene for cabinet with 2 doors	1025x545x70	39	70
TIM24	Daily counter	-	-	-
ALLARME	Alarm system for «open doors»	-	-	-

*Approximate capacity in bottles holding 1 litre

→ VENTILATION (optional)

CODE	DESCRIPTION	DIMENSIONS (WxDxH) mm
2CP104	Fresh air box with panelling for cabinet with 1 door - connecting Ø 125 mm	600x600x300
2CP106	Fresh air box with panelling for cabinet with 2 doors - connecting Ø 125 mm	1140x600x300
DIAM125BP	Fresh air box with filter holding box for high cabinet with 1 or 2 doors - outlet Ø 125 mm (filter excluded)	290x290x270
RSOLCA	Activated charcoal filter for motor DIAM125BP - (to replace at least twice a year)	235x110x15
RE1000	Fan flow controller (to be ordered with the fan DIAM125BP)	-
GFKIT125	Connection kit: 1 metre of flexible sheath Ø 125 mm and 2 clamps	Ø 125 mm
CFN	Fresh air box with molecular filtration according to standard NFX15-211, with visual and audible alarm	550x500x220
CFNL	Molecular filtration box manufactured, without alarm	550x500x220
CFNCO	Hour counter for CFN	
CSAS	Activated charcoal filter for solvents (prefilter included)	510x405x60
CSBE	Activated charcoal filter for acids (prefilter included)	510x405x60
CSMP	Activated charcoal filter for solvents and acids (prefilter included)	510x405x60
CSPF	Prefilter	510x405x15
RFC560	Filter for 60 Basic (spare part for CS60 and CS60A+B)	
RFC5120	Filter for 120 Basic (spare part for CS120)	

*To obtain the complete list of the connection accessories, see the chapter on ventilation of this catalogue and the current price list

Series MULTIRISK Plain doors



CSB120



CSB124



CSB60UB



CSB120UB



CSB60



CSB62



CSB63

Modular solutions
to store your chemicals



External hinge made of plastic
resistant to corrosion

→ TECHNICAL FEATURES:

- Completely made of an electrogalvanized steel plate with a thickness of 15/10 mm, cold bent
- External finishing made of acidproof epoxy resin 90 microns Grey RAL7035 and passage through a thermal tunnel at 200 °C
- Construction in one piece with leveling jacks
- Division in 2, 3 or 4 compartments for storing separately the different families of nonflammable chemical products
- Plain swing doors with a single wall
- Key lock
- Door opening with an angle of 110°
- External hinge made of plastic resistant to corrosion
- Compartments equipped with **fixed** retention shelves made of **plasticated, painted** and **stainless** steel whose height can be adjusted
- Ø 125 mm connection collar
- Standardized pictograms according to standards ISO 3864

→ SERIES MULTIRISK PLAIN DOORS

CODE	DESCRIPTION	EXTERNAL DIMENSIONS (WxDxH) mm	INTERNAL DIMENSIONS (WxDxH) mm	INTERNAL EQUIPMENT	STORAGE CAPACITY*	Weight Kg
CSB60	Cabinet with 1 door 1 compartment	600x600x1950	595x540x1864	3 shelves made of plasticated steel (max load 40 Kg evenly distributed)	105	68
CSB62	Cabinet with 2 doors 2 superimposed compartments	600x600x1950	595x540x930+930	Compartment for ACIDS: 2 shelves made of plasticated steel Compartment for BASES: 2 fixed shelves made of stainless steel (max load 40 Kg evenly distributed)	140	70
CSB63	Cabinet with 3 doors 3 superimposed compartments	600x600x1950	595x540x618+618+618	Compartment for ACIDS: 2 shelves made of plasticated steel Compartment for BASES: 2 shelves made of stainless steel Compartment for TOXICS: 2 shelves made of painted steel (max load 40 KG evenly distributed)	210	73
CSB120	Cabinets with 2 doors 1 compartment	1200x600x1950	1130x540x1864	3 shelves made of plasticated steel (max load 80 KG evenly distributed)	210	125
CSB124	Cabinets with 4 doors 4 compartments (2+2)	1200x600x1950	568+568x540x930+930	Compartment for ACIDS: 2 shelves made of plasticated steel Compartment for BASES: 2 shelves made of stainless steel Compartment for TOXICS: 2 shelves made of painted steel Compartment for HARMFUL PRODUCTS: 2 shelves made of painted steel (max load 40 KG evenly distributed)	280	135
CSB60UB	Underbench cabinet with 1 door - 1 compartment	600x600x700	595x540x620	2 shelves made of plasticated steel (max load 40 Kg evenly distributed)	70	35
CSB120UB	Cabinet with 2 doors 1 compartment	1200x600x700	1130x540x620	2 shelves made of plasticated steel (max load 80 Kg evenly distributed)	140	50

*Approximate capacity in bottles holding 1 litre per cabinet

→ INTERNAL EQUIPMENT (optional)

CODE	DESCRIPTION	DIMENSIONS (WxDxH) mm	RETENTION VOLUME (LITRES)	STORAGE CAPACITY*
CSB60R	Additional fixed shelf made of plasticated steel for cabinet with 1 door	595x539x39	12	35
CSB60RI	Additional fixed shelf made of stainless steel for cabinet with 1 door	595x539x39	12	35
CSB120R	Additional fixed shelf made of plasticated steel for cabinet with 2 doors	1130x539x39	22	70
CSB120RI	Additional fixed shelf made of stainless steel for cabinet with 2 doors	1130x539x39	22	70
CSB124R	Additional plasticated shelf for cabinet with 4 doors	576x537x39	12	38
CSB124RI	Additional stainless steel shelf for cabinet with 4 doors	576x537x39	12	38
TIM24	Daily counter	-	-	-
ALLARME	Alarm system for «open doors»	-	-	-

*Approximate capacity in bottles holding 1 litre

→ VENTILATION (optional)

CODE	DESCRIPTION	DIMENSIONS (WxDxH) mm
DIAM125BP	Fresh air box with filter holding box for high cabinet with 1 or 2 doors - outlet Ø 125 mm (filter excluded)	290x290x270
RSOLCA	Activated charcoal filter for motor DIAM125BP - (to replace at least twice a year)	235x110x15
F125	Ø 125 mm connection collar for underbench cabinets	Ø125 mm
RE1000	Fan flow controller (to be ordered with the fan DIAM125BP)	-
GFKIT125	Connection kit: 1 metre of flexible sheath Ø 125 mm and 2 clamps	Ø 125 mm
CFN	Fresh air box with molecular filtration according to standard NFX15-211, with visual and audible alarm	550x500x220
CFNL	Molecular filtration box manufactured, without alarm	550x500x220
CFNCO	Hour counter for CFN	
CFNUB	Filtration box certified according to standard NFX15-211 for underbench cabinets, equipped with wheels, 2 ventilation outlets, with visual and audible alarm	400x500x650
CFNUBL	Filtration box for underbench cabinets, equipped with wheels, 2 ventilation outlets	400x500x650
CSAS	Activated charcoal filter (prefilter included)	510x405x60
CSBE	Activated charcoal filter for acids (prefilter included)	510x405x60
CSMP	Activated charcoal filter for solvents and acids (prefilter included)	510x405x60
CSPF	Prefilter	510x405x15

*To obtain the complete list of the connection accessories, see the chapter on ventilation of this catalogue and the current price list

Series MULTIRISK Glazed doors



CSB120G



CSB124G



External hinge made of plastic resistant to corrosion

Modular solutions to store your chemicals



CSB60G



CSB62G



CSB63G

→ TECHNICAL FEATURES:

- Completely made of an electrogalvanized steel plate with a thickness of 15/10 mm, cold bent
- External finishing made of acidproof epoxy resin 90 microns Grey RAL7035 and passage through a thermal tunnel at 200 °C
- Construction in one piece with leveling jacks
- Division in 2, 3 or 4 compartments for storing separately the different families of nonflammable chemical products
- Swing doors with single wall and polycarbonate glass, highly resistant to chemical attacks
- Key lock
- Door opening with an angle of 110°
- External hinge made of plastic resistant to corrosion
- Compartments equipped with **fixed** retention shelves made of **plasticated**, **painted** and **stainless** steel whose height can be adjusted
- Ø 125 mm connection collar
- Standardized pictograms according to standards ISO 3864

→ SERIES MULTIRISK GLAZED DOORS

CODE	DESCRIPTION	EXTERNAL DIMENSIONS (WxDxH) mm	INTERNAL DIMENSIONS (WxDxH) mm	INTERNAL EQUIPMENT	STORAGE CAPACITY*	Weight (Kg)
CSB60G	Cabinet with 1 glazed door 1 compartment	600x600x1950	595x540x1864	3 shelves made of plasticated steel (max load 40 Kg evenly distributed)	105	68
CSB62G	Cabinet 2 glazed doors 2 superimposed compartments	600x600x1950	595x540x930+930	Compartment for ACIDS: 2 shelves made of plasticated steel Compartment for BASES: 2 fixed shelves made of stainless steel (max load 40 Kg evenly distributed)	140	70
CSB63G	Cabinet 3 glazed doors 3 superimposed compartments	600x600x1950	595x540x618+618+618	Compartment for ACIDS: 2 shelves made of painted steel Compartment for BASES: 2 shelves made of stainless steel Compartment TOXICS: 2 shelves made of painted steel (max load 40 Kg evenly distributed)	210	73
CSB120G	Cabinet with 2 glazed doors 1 compartment	1200x600x1950	1130x540x1864	3 shelves made of painted steel (max load 80 Kg evenly distributed)	210	125
CSB124G	Cabinet with 4 glazed doors 4 compartments (2+2)	1200x600x1950	568+568x540x930+930	Compartment for ACIDS: 2 shelves made of plasticated steel Compartment for BASES: 2 shelves made of stainless steel Compartment TOXICS: 2 shelves made of painted steel Compartment for HARMFUL PRODUCTS: 2 shelves made of painted steel (max load 40 Kg evenly distributed)	280	135

*Approximate capacity in bottles holding 1 litre per cabinet

→ INTERNAL EQUIPMENT (optional)

CODE	DESCRIPTION	DIMENSIONS (WxDxH) mm	RETENTION VOLUME (LITRES)	STORAGE CAPACITY*
CSB60R	Additional fixed shelf made of plasticated steel for cabinet with 1 door	595x539x39	12	35
CSB60RI	Additional fixed shelf made of stainless steel for cabinet with 1 door	595x539x39	12	35
CSB120R	Additional fixed shelf made of plasticated steel for cabinet with 2 doors	1130x539x39	22	70
CSB120RI	Additional fixed shelf made of stainless steel for cabinet with 2 doors	1130x539x39	22	70
CSB124R	Additional plasticated shelf for cabinet with 4 doors	576x537x39	12	38
CSB124RI	Additional stainless steel shelf for cabinet with 4 doors	576x537x39	12	38
TIM24	Daily counter	-	-	-
ALLARME	Alarm system for «open doors»	-	-	-

*Approximate capacity in bottles holding 1 litre

→ VENTILATION (optional)

CODE	DESCRIPTION	DIMENSIONS (WxDxH) mm
DIAM125BP	Fresh air box with filter holding box for high cabinet with 1 or 2 doors - outlet Ø 125 mm (filter excluded)	290x290x270
RSOLCA	Activated charcoal filter for motor DIAM125BP - (to replace at least twice a year)	235x110x15
F125	Ø 125 mm connection collar for underbench cabinets	Ø125 mm
RE1000	Fan flow controller (to be ordered with the fan DIAM125BP)	-
GFKIT125	Connection kit: 1 metre of flexible sheath Ø 125 mm and 2 clamps	Ø 125 mm
CFN	Fresh air box with molecular filtration according to standard NFX15-211, with visual and audible alarm	550x500x220
CFNL	Molecular filtration box manufactured, without alarm	550x500x220
CFNCO	Hour counter for CFN	
CFNUB	Filtration box certified according to standard NFX15-211 for underbench cabinets, equipped with wheels, 2 ventilation outlets, with visual and audible alarm	400x500x650
CFNUBL	Filtration box for underbench cabinets, equipped with wheels, 2 ventilation outlets	400x500x650
CSAS	Activated charcoal filter (prefilter included)	510x405x60
CSBE	Activated charcoal filter for acids (prefilter included)	510x405x60
CSMP	Activated charcoal filter for solvents and acids (prefilter included)	510x405x60
CSPF	Prefilter	510x405x15

*To obtain the complete list of the connection accessories, see the chapter on ventilation of this catalogue and the current price list

BOX FOR POISON STORAGE

Specially conceived for storing and isolating poisons, toxic chemical products and CMR.



CS105+CS107



CS107

It can be used
as wall cabinet to store
your harmful products
or as poison box
in a storage cabinet

→ TECHNICAL FEATURES:

- Made of steel 10/10th
- Colour: Grey RAL7035
- Equipped with 2 retention shelves made of epoxy plasticated steel, whose height can be adjusted
- Swing door with **double wall** and key lock
- Door opening with an angle higher than 110°
- Prearrangement for wall mountin
- Possibility of fastening in a safety cabinet (on the shelf or on the cabinet bottom wall)
- Standardized pictograms according to standards ISO 3864

→ POISON BOX

CODE	DESCRIPTION	EXTERNAL DIMENSIONS (WxDxH) mm	INTERNAL DIMENSIONS (WxDxH) mm	INTERNAL EQUIPMENT	STORAGE CAPACITY*	Weight (kg)
CS107	Poison box	500x300x400	480x270x390	2 shelves made of plasticated steel (max load 5 Kg evenly distributed)	25	10

*Approximate capacity in bottles holding 1 litre per cabinet

Series E-LINE

Safety cabinets

The cabinets of series E-LINE represent the ideal solution for a cheap and safe storage of all your polluting, toxic and dangerous products.

Practical and cheap
Ideal for storing
your products



E740/54

E740

→ TECHNICAL FEATURES:

- Made of steel 8/10th
- Colour: Grey RAL7035
- Equipped with retention shelves made of epoxy painted steel, whose height can be adjusted
- Plain swing doors with **single wall** and 3 point key lock
- Door opening with an angle higher than 110°
- Ø 125 mm connection collar
- Standardized pictograms according to standards ISO 3864



E740/54S



E740/S

→ SERIES E-LINE

CODE	DESCRIPTION	EXTERNAL DIMENSIONS (WxDxH) mm	INTERNAL DIMENSIONS (WxDxH) mm	INTERNAL EQUIPMENT	STORAGE CAPACITY*	Weight (Kg)
E740/54	High cabinet with 1 door	540x450x2000	530x430x1980	3 shelves + 1 retention tray made of painted steel (max load 40 Kg evenly distributed)	64	45
E740	High cabinet with 2 doors	1000x450x2000	990x430x1980	3 shelves + 1 retention tray made of painted steel (max load 80 Kg evenly distributed)	100	65
E740/54S	Cabinet counter with 1 door	540x450x1000	530x430x998	1 shelf + 1 retention tray made of painted steel (max load 40 Kg evenly distributed)	30	35
E740/S	Cabinet counter with 2 doors	1000x450x1000	990x430x998	1 shelf + 1 retention tray made of painted steel (max load 80 Kg evenly distributed)	70	45

*Approximate capacity in bottles holding 1 litre per cabinet

→ INTERNAL EQUIPMENT (optional)

CODE	DESCRIPTION	DIMENSIONS (WxDxH) mm	RETENTION VOLUME (LITRES)	STORAGE CAPACITY*
CRF600G	Additional shelf made of painted steel for cabinet with 1 door	537x415x30	6	16
CRF900G	Additional shelf made of painted steel for cabinet with 2 doors	990x415x30	12	36

*Approximate capacity in bottles holding 1 litre

→ VENTILATION (optional)

CODE	DESCRIPTION	DIMENSIONS (WxDxH) mm
DIAM125BP	Fresh air box with filter holding box for high cabinet with 1 or 2 doors inlet/outlet Ø 125 mm (filter excluded)	290x290x270
RE1000	Fan flow controller (to be ordered with the fan DIAM125BP)	-
GFKIT125	Connection kit: 1 metre of flexible sheath Ø 125 mm and 2 clamps	Ø 125 mm
TIM24	Daily counter	-

*To obtain the complete list of the connection accessories, see the chapter on ventilation of this catalogue and the current price list



→ TECHNICAL FEATURES:

- Completely made of an electrogalvanized steel plate with a thickness of 10/10 mm, cold bent
- External finishing made of acidproof epoxy resin 90 microns Grey RAL7035 and passage through a thermal tunnel at 200 °C
- Construction in one piece with leveling jacks
- Plain swing or glazed doors with double wall
- Door opening with an angle of 110° allowing extracting the shelves without tilting them
- Key lock
- Equipped with 3 retention shelves made of STAINLESS steel, with a thickness of 10/10 mm, whose height can be adjusted
- Ventilation unit included **CE** with box made of painted steel and aluminium propeller
- Protection degree: IP44 according to UNEL-IEC
- Flow 300 m³/h
- Sound level lower than 6dB at the moment of the maximum flow with 1.5 m sheath according to UNI 7179-73P
- Mp. 0.09 Kw., 2900 revolutions.
- Complying with standard EN61010
- Supply: 220/230V 50Hz single phase
- Absorption: 90W
- Connection diameter: 100 mm
- Equipped with a particle filter HEPA H14 made of glass micro-fibre with MPPS 99,995%, flow 150 m³/h, structure made of anodized aluminium
- Equipped with an activated charcoal filter for acids with a big absorption surface
- Filter replacement made easier by the hinge system with key lock
- Standardized pictograms according to standards ISO 3864

→ SERIES CYTOTOXIC

CODE	DESCRIPTION	EXTERNAL DIMENSIONS (WxDxH) mm	INTERNAL DIMENSIONS (WxDxH) mm	INTERNAL EQUIPMENT	CSTORAGE CAPACITY*	Weight (kg)
CS103H	Cabinet with 1 plain door	600x600x1900 (1600+300)	550x550x1500	3 shelves made of stainless steel (490x550x30 mm)	100	93
CS106H	Cabinet with 2 plain doors	1140x600x1900 (1600+300)	1080x550x1500	3 shelves made of stainless steel (1030x550x30 mm)	200	130
CS103GH	Cabinet with 1 glazed door	600x600x1900 (1600+300)	550x550x1500	3 shelves made of stainless steel (490x550x30 mm)	100	95
CS106GH	Cabinet with 2 glazed doors	1140x600x1900 (1600+300)	1080x550x1500	3 shelves made of stainless steel (1030x550x30 mm)	200	133

*Approximate capacity in bottles holding 1 litre per cabinet

→ INTERNAL EQUIPMENT (optional)

CODE	DESCRIPTION	DIMENSIONS (WxDxH) mm	STORAGE CAPACITY*
RIPX60	Additional fixed shelf made of stainless steel for cabinet with 1 door	485x545x30	35
RIPX120	Additional fixed shelf made of stainless steel for cabinet with 2 doors	1025x545x30	70
RFC60	Filter for 60 Basic (spare part for CS60 and CS60 A+B)		
RFC120	Filter for 120 Basic (spare part for CS120)		
RFCHEPA	Hepa filter (spare part)		

*Approximate capacity in bottles holding 1 litre

Standard NFX15-211

➔ WHAT THE STANDARD SAYS

This standard defines precisely the filtration system capacity of a fume hood to retain the harmful molecules evaporated in the enclosure and qualifies the air quality after the filter.

During the « normal operation» phase, standard AFNOR NF X 15 211 imposes a maximum concentration after the filtration system which must not exceed 1% of the TLV of the product handled.

Standard AFNOR NF X 15 211 deals with the performances of a fume hood as a whole: containment, speed, filtration system effectiveness. This standard does not define in any case the properties of a single and isolated filter of a filtration system. Therefore, a single filter cannot comply with standard AFNOR NFX 15 211.

Mandated by AFNOR, the Union de Normalisation Mécanique (UNM), made of a board of experts for ventilation, of government bodies, of professional trade union members, established standard AFNOR NFX 15-211:2009. This standard applies to fume hoods conceived for research and analysis works... for all laboratories handling chemical agents subject to a professional exposure limit value (TLV or OEL). This text imposes some performance criteria connected to:

- 1 - The filtration effectiveness
- 2 - The containment effectiveness
- 3 - The air effectiveness on the front
- 4 - The documentation accompanying the fume hoods

CLASS 1	CLASS 2
Fume hoods with safety reserve	Fume hoods without safety reserve
One main filtration level and one safety filtration level	Un niveau de filtration principal

The classes of standard AFNOR NFX 15-211: 2009

DENOMINATION ACCORDING TO NFX 15-211 :2009	
Particle filtration	Type P
Vapour filtration	Type V
Particle and vapour filtration	Type PV

	CLASS 1	CLASS 2
Normal operating phase	Normal operating phase during which the concentration after the filter must be lower than 1% of TLV	
Detection phase	Detection phase during which the concentration after the filters must be lower than 1% of TLV and during which the automatic detector of saturation must warn the user	Detection phase during which the concentration after the filters must be lower than 50% of TLV
Safety phase	Safety phase during which the concentration after the filters must be lower than 50% of TLV and whose duration must not be lower than 1/12 of the duration of the normal operating phase	

Special prescriptions for enclosures of class 1

The enclosures of class 1 must be conceived for handling products whose OEL is higher or equal to 1 ppm.

The enclosures of class 1 must include a continuous measuring system of concentration, after the filter, associated to an alarm.

1 - The filtration effectiveness

It indicates the filter capacity to retain the harmful molecules handled in the enclosure and qualifies the recirculated air quality after the filter.

2 - The containment effectiveness

It defines the fume hood capacity to retain the vapours or the particles in the enclosure without dispersing them into the laboratory atmosphere.

3 - The air effectiveness on the front

It indicates the fume hood capacity to create a dynamic barrier between the operator and what he handles.

For fume hoods with fixed front, the front air speed at any point along the opening must be between 0.4 and 0.6 m/s. Furthermore, they must be equipped with a continuous monitoring device of ventilation.

4 - The documentation accompanying the fume hoods

The fume hoods must be accompanied by a booklet including an exhaustive list of the chemical agents that according to the manufacturer's certification can be handled in the fume hood in compliance with the conditions described in standard NFX 15-211:2009

Special prescriptions for enclosures of class 2

The enclosures of class 2 must be conceived for handling products whose OEL is higher or equal to 10 ppm.

The enclosures of class 2 must include:

- Either an (audible or visual) alarm triggered by an hour meter every 60 working hours
- Or a continuous measuring system of the concentration after the filter connected to an alarm

The product mass that can be inserted into the enclosure must not exceed 1/8 of the retention capacity of the filter during normal operation.

➤ OPERATING PRINCIPLE OF A FUME HOOD

➔ OPERATION OF AN ACTIVATED CHARCOAL FUME HOOD

The harmful vapours are contained in the working volume, sucked by the ventilation unit and purified through their passage in the activated charcoal filter before being rejected into the atmosphere. You will find below the important parameters to consider for the good operation of the activated charcoal filter:

➔ CONCENTRATION

The higher the concentration of the handled products, the higher the quantity of coal that will be necessary.

➔ TEMPERATURE

The lower the temperature, the better the absorption capacity.

➔ PRESSURE

The higher the pressure, the better the absorption capacity.

➔ HUMIDITY

The lower the humidity, the better the absorption capacity.

➔ AIR FLOW SPEED

through the activated charcoal filter (0.2 m/s).

While the first 4 parameters are generally constant in a laboratory, the air speed is given by the suction system.

We conceived an electronic measuring system, allowing checking this fundamental parameter in order to optimize the absorption of chemical substances through the «coal bed». An anemometer sensor controls the speed of the air passage through the activated charcoal filter (about 0.2 m/s). It sends this information to the microprocessor validating the value if it is correct via a green light-emitting diode (LED) on the control panel. In case of a speed lower than 0.2 m/s, a red light-emitting diode LED flashes slowly.

If the speed is much higher than 0.2 m/s, the same red diode LED will flash more quickly. In these two cases, it will be possible to intervene manually to restore the good speed by means of the electronic regulator. In this way the inlet air flow speed on the front will be between 0.4 and 0.6 m/s.

These are the results obtained starting from the fume HOOD CHEMIHOOD PLUS:

➔ Results of the test with carbon tetrachloride (CCl₄)

OPERATION	NORMAL	DETECTION	SAFETY	OCCURRENCE
Average air temperature (°C)	21,0	20,3	20,5	19,8
Average relative humidity (%)	55	54	59	52
Sampling flow (L/min)	0,8	0,8	0,8	0,8
Sampling time (min)	480	480	480	480
Treated air volume (m ³)	0,382	0,381	0,383	0,384
Mass of CCl ₄ absorbed (g)	2542	113	175	165
Concentration of CCl ₄ rejected (ppm)	0	0	0	0
Volume discharged (ml)	/	/	/	180
% OEL	0	0	0	0
% TLV	0	0	0	0

➔ Results of the test with hydrochloric acid (HCl)

OPERATION	NORMAL	DETECTION	SAFETY	OCCURRENCE
Average air temperature (°C)	20,6	21,1	20,8	20,9
Average relative humidity (%)	54	53	54	52
Sampling flow (L/min)	0,8	0,8	0,8	0,8
Sampling time (min)	480	480	480	480
Treated air volume (m ³)	0,382	0,383	0,382	0,382
Mass of CCl ₄ absorbed (g)	1588	776	134	287
Concentration of CCl ₄ rejected (ppm)	0	0	0,04	3,93
Volume discharged (ml)	/	/	/	100
% OEL	/	/	/	/
% TLV	0	0	0,8	78,6

➤ OPERATING PRINCIPLE OF A FILTERING CABINET

The harmful vapours contained in the storage cabinet are sucked by the ventilation box and purified when they pass through the activated charcoal filter before being rejected into the atmosphere. The vapour filtration occurs in a specific manner by choosing a suitable activated charcoal filter.

All toxic vapours emitted by the storage of chemicals are eliminated by ensuring a purified air inside the laboratory.

This system, which is easier and cheaper to implement, allows the cabinet ventilation without any external connection and without air compensation problems in the room. The ventilated cabinet can be installed everywhere in your laboratory and near workstations.

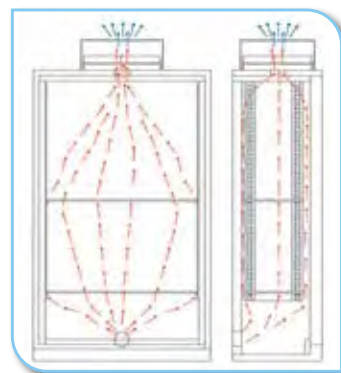
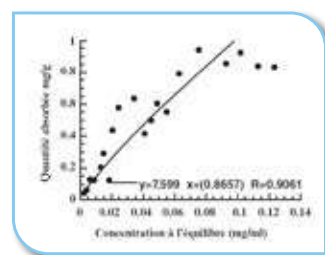
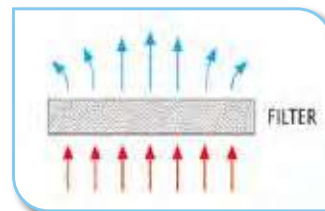

Series CFCS - Fixed shelves - Glass doors

Certified according to NFX15-211 & EN61010-1



CFCS-103GP



CFCS-104/2CV



CFCS-106GP

Safely removing noxious vapours
with no need of external connections



→ TECHNICAL FEATURE OF CABINETS:

- Completely made of electrogalvanized stainless steel with a thickness of 10/10 mm, cold bent - Grey RAL7035
- External finishing made of acidproof epoxy resin and passage through a thermal tunnel at 200 °C
- One-piece structure with levelling jacks
- **Swing door with double wall, provided with glass Sécurité 6 mm (3 mm + polyvinyl film + 3 mm)**
- Key lock
- Door opening with an angle of 110° allowing extracting the shelves without tilting them
- Equipped with 4 fixed shelves + 1 retention tray made of plasticated steel, whose height can be adjusted, **per compartment**
- Standardized pictograms according to standards ISO 3864
- **Complying with standards EN 601010-1 & CEI 66-5**
- Complying with articles 5162 and 5170 of the Public Health Code
- Equipped with a filtering fresh air box complying with the standard AFNOR NFX 15-211 **(filter should be chosen according to the stored products)**

→ TECHNICAL FEATURES OF THE FRESH AIR BOX WITH FILTRATION:

- Electrogalvanized steel structure 10/10 mm, covered in a light blue epoxy paint
- Axial fan (turbine)
- Flow rate: 100/250 m³/h
- Voltage/frequency: 220 volts/50Hertz
- IP44
- Acoustic level 45dB
- Complying with the standard ISO 3744
- ON/OFF switch with light indicators for proper working
- LED visual and acoustic working hour meter
- Filter saturation indicator with LED visual and acoustic indicator: speed measurement of the air passing through the activated charcoal filter
- Retention capacity CCl₄ on a 7000g-filter (in compliance with the efficiency level defined by the **standard AFNOR NFX 15-211**) or maximum rejection of 50% of the average exposure value of the product
- Please see the ventilation chapter for the detailed sheet of the fresh air box with filtration in compliance with the standard NFX 15-211

→ SERIE CFCS

CODE	DESCRIPTION	EXTERNAL DIMENSIONS (WxDxH) mm	INTERNAL DIMENSIONS (WxDxH) mm	INTERNAL EQUIPMENT	STORAGE CAPACITY*	Weight (kg)
CFCS-103GP	Cabinet Series CSF6 Cabinet with 1 glass door	600x600x1950	595x567x1864	4 shelves made of plasticated steel (max load 40 Kg evenly distributed) + 1 retention tray with grid made of plasticated steel and absorbent mat	170	95
CFCS-106GP	Cabinet Series CSF12 Cabinet with 2 glass doors 2 compartments	1140x600x1950	503+503x567x1864	4 shelves made of plasticated steel (max load 40 Kg evenly distributed) + 1 retention tray with grid made of plasticated steel and absorbent mat per compartment	350	180
CFCS-104/2CV	Cabinet Series COMBICHEM F 2C Cabinet with 2 glass doors 2 superimposed compartments	600x600x1950	595x567x930+930	2 shelves made of plasticated steel (max load 40 Kg evenly distributed) + 1 retention tray with grid made of plasticated steel and absorbent mat per compartment	210	115

*Approximate capacity in bottles holding 1 litre per cabinet

→ INTERNAL EQUIPMENT (OPTIONAL)

CODE	DESCRIPTION	DIMENSIONS (WxDxH) mm	RETENTION VOLUME (LITRES)	STORAGE CAPACITY*
RIPCS60	Additional fixed shelf made of plasticated steel for cabinet with 1 door	485x545x30	9	35
RIPCS120	Additional fixed shelf made of plasticated steel for cabinet with 2 doors	1025x545x30	19	70
RIPX60	Additional fixed shelf made of stainless steel for cabinet with 1 door	485x545x30	9	35
RIPX120	Additional fixed shelf made of stainless steel for cabinet with 2 doors	1025x545x30	19	70
VACS60	Additional retention tray made of plasticated steel for cabinet with 1 door	485x545x70	18	35
CS-ABS	Absorbent paper - set of 4 sheets 500x400 mm	-	-	-
ALLARME	Alarm system "open doors"	-	-	-

*Approximate capacity in bottles holding 1 litre

→ VENTILATION

CODE	DESCRIPTION	DIMENSIONS (WxDxH) mm
CFN	Fresh air box with molecular filtration according to standard NFX15-211, with visual and acoustic alarm - supplied along with the cabinet	550x500x220
CSAS	Activated charcoal filter for solvents (prefilter included)	510x405x60
CSBE	Activated charcoal filter for acids (prefilter included)	510x405x60
CSMP	Activated charcoal filter for solvents and acids (prefilter included)	510x405x60
CSPF	Prefilter	510x405x15

*To obtain the complete list of the connection accessories, see the chapter on ventilation of this catalogue and the current price list

Series CFCS - Sliding shelves - Glass doors

Certified according to NFX15-211 & EN61010-1



CF4TCS-103GP



CF8TCS-108GP

Easy access to bottles thanks to the sliding shelves



→ TECHNICAL FEATURE OF CABINETS:

- Completely made of electrogalvanized stainless steel with a thickness of 10/10 mm, cold bent - Grey RAL7035
- External finishing made of acidproof epoxy resin and passage through a thermal tunnel at 200 °C
- One-piece structure with levelling jacks
- **Swing door with double wall, provided with glass Sécurité 6 mm (3 mm + polyvinyl film + 3 mm)**
- Key lock
- Door opening with an angle of 110° allowing extracting the shelves without tilting them
- Equipped with sliding shelves and retention tray with grid made of plasticated steel and absorbent mat
- Standardized pictograms according to standards ISO 3864
- **Complying with standards EN 601010-1 & CEI 66-5**
- Complying with articles 5162 and 5170 of the Public Health Code
- Equipped with a filtering fresh air box complying with the standard AFNOR NFX 15-211 **(filter should be chosen according to the stored products)**

→ TECHNICAL FEATURES OF THE FRESH AIR BOX WITH FILTRATION:

- Electrogalvanized steel structure 10/10 mm, covered in a light blue epoxy paint
- Axial fan (turbine)
- Flow rate: 100/250 m³/h
- Voltage/frequency: 220 volts/50Hertz
- IP44
- Acoustic level 45dB
- Complying with the standard ISO 3744
- ON/OFF switch with light indicators for proper working
- LED visual and acoustic working hour meter
- Filter saturation indicator with LED visual and acoustic indicator: speed measurement of the air passing through the activated charcoal filter
- Retention capacity CCl₄ on a 7000 g-filter (in compliance with the efficiency level defined by the **standard AFNOR NFX 15-211**) or maximum rejection of 50% of the average exposure value of the product
- Please see the ventilation chapter for the detailed sheet of the filtering fresh air box in compliance with the standard NFX 15-211

→ SERIES CFCS

CODE	DESCRIPTION	EXTERNAL DIMENSIONS (WxDxH) mm	INTERNAL DIMENSIONS (WxDxH) mm	INTERNAL EQUIPMENT	STORAGE CAPACITY*	Weight (kg)
CF4TCS-103GP	Cabinet Series CSF6 Cabinet with 1 glass door	600x600x1950	595x567x1864	4 shelves made of plasticated steel (max load 40 Kg evenly distributed) + 1 retention tray with grid made of plasticated steel and absorbent mat	170	95
CF8TCS-106GP	Cabinet Series CSF12 Cabinet with 2 glass doors 2 compartments	1140x600x1950	503x503x567x1864	4 shelves made of plasticated steel (max load 40 Kg evenly distributed) + 1 retention tray with grid made of plasticated steel and absorbent mat per compartment	350	180
CF4TCS-104/ZCV	Cabinet Series COMBICHEM F 2C Cabinet with 2 glass doors 2 superimposed compartments	600x600x1950	595x567x930x930	2 shelves made of plasticated steel (max load 40 Kg evenly distributed) + 1 retention tray with grid made of plasticated steel and absorbent mat per compartment	210	115
CF4TCS-104/ZC	Cabinet Series COMBICHEM F 2C Cabinet with 2 plain doors 2 superimposed compartments	600x600x1950	595x567x930x930	2 shelves made of plasticated steel (max load 40 Kg evenly distributed) + 1 retention tray with grid made of plasticated steel and absorbent mat per compartment	210	110

*Approximate capacity in bottles holding 1 litre per cabinet

→ INTERNAL EQUIPMENT (OPTIONAL)

CODE	DESCRIPTION	DIMENSIONS (WxDxH) mm	RETENTION VOLUME (LITRES)	STORAGE CAPACITY*
RIPCS60	Additional fixed shelf made of plasticated steel for cabinet with 1 door	485x545x30	9	35
RIPX60	Additional fixed shelf made of painted steel for cabinet with 1 door	485x545x30	9	35
RIP60SC	System for sliding shelf - factory assembly	-	-	-
VACS60	Additional retention tray made of plasticated steel for cabinet with 1 door	485x545x70	18	35
CS-ABS	Absorbent paper - set of 4 sheets 500x400 mm	-	-	-
ALLARME	Alarm system "open doors"	-	-	-

*Approximate capacity in bottles holding 1 litre

→ VENTILATION

CODE	DESCRIPTION	DIMENSIONS (WxDxH) mm
CFN	Fresh air box with molecular filtration according to standard NFX15-211, with visual and acoustic alarm supplied along with the cabinet	550x500x220
CSAS	Activated charcoal filter for solvents (prefilter included)	510x405x60
CSBE	Activated charcoal filter for acids (prefilter included)	510x405x60
CSMP	Activated charcoal filter for solvents and acids (prefilter included)	510x405x60
CSPF	Prefilter	510x405x15

*To obtain the complete list of the connection accessories, see the chapter on ventilation of this catalogue and the current price list

Hoods CHEMIHOOD PLUS with molecular filtration

Certified according to NFX15-211

Hoods with molecular filtration



The safest
and cheapest system
to handle chemicals



CHSCASPE120



CSF-003P



CSF-002P

→ HOW DOES A FUME HOOD WORK?

Hoods CHEMIHOOD PLUS provide the users with a safe working area to handle chemicals.

Easier and cheaper to use than those of chimney extractors, this system allows the extraction of noxious vapours with no need of external connections and without any issue relating to air compensation inside the room. Equipped with filters dedicated to specific applications, they comply with the most demanding standards in the world: STANDARD AFNOR NFX 15-211. CHEMIHOOD PLUS hoods, enclosure of class II, have been tested according to standard NFX 15-211 by an independent lab and certified according to the supervising office AJA Europe.

→ TECHNICAL FEATURES OF THE FRESH AIR BOX WITH FILTRATION:

- Electrogalvanized steel structure 10/10 mm, covered in a light blue epoxy paint
- Axial fan (turbine)
- Flow rate: 100/250 m³/h
- Voltage/frequency: 220 volts/50Hertz
- IP44
- Acoustic level 45dB
- Complying with the standard ISO 3744
- ON/OFF switch with light indicators for proper working. Working hour meter with LED visual and acoustic indicator
- Filter saturation indicator with LED visual and acoustic indicator: speed measurement of the air passing through the activated charcoal filter
- Retention capacity CCl₄ on a 7000g-filter (in compliance with the efficiency level defined by the standard AFNOR NFX 15-211) or maximum rejection of 50% of the average exposure value of the product
- Filter should be chosen according to the handled products
- Optional sample draw pump by means of colorimetric check
- Please see the ventilation chapter for the detailed sheet of the fresh air box with filtration in compliance with the standard NFX 15-211

A saturated filter is an inefficient filter

To protect personnel and environment, change your filters regularly!

You can also test the filter saturation by means of a colorimetric check using a suction pump. Please feel free to contact us.

→ TECHNICAL FEATURES OF HOODS:

- Completely made of "optical" methyl methacrylate with a thickness of 8 mm, CHEMIHOOD PLUS hoods provide an optimal, bright vision without distortions
- Tilted front side (7°) - ergonomic position at the work place
- Front panel can be totally lifted and blocked, so that access is easier in case of voluminous equipment, chemicals or cleaning operations
- Two lids to allow the passing of arms for easy handle ensuring the utmost safety
- Possibility of inserting of electric cables and fluids inside the enclosure trough the cable ducts on the sides
- Retention tray made of stainless steel to recover liquids in the event of accidental spillage
- Possibility of adding a work surface made of enamelled glass or HPL with a thickness of 6 mm
- Available in three widths: 600 mm, 900 mm and 1200 mm
- Possibility of placing the hood on a mobile base with or without shelf
- Equipped with a filtering fresh air box complying with the standard AFNOR NFX 15-211 (filter should be chosen according to the stored products)

→ HOTTES CHEMIHOOD PLUS

CODE	DESCRIPTION	EXTERNAL DIMENSIONS (WxDxH) mm	INTERNAL DIMENSIONS (WxDxH) mm	INTERNAL EQUIPMENT	Weight (kg)
CSF-001P	Filtering Fume hood W600 mm certified according to standard NFX15-211, with acoustic and visual alarm	600x600x1000	584x584x800	1 retention tray made of stainless steel	41
CSF-002P	Filtering Fume hood W900 mm certified according to standard NFX15-211, with acoustic and visual alarm	900x600x1000	884x584x800	1 retention tray made of stainless steel	51
CSF-003P	Filtering Fume hood W1135 mm certified according to standard NFX15-211, with acoustic and visual alarm	1135x600x1000	1119x584x800	1 retention tray made of stainless steel	57

→ INTERNAL EQUIPMENT (optional - the choice of a filter is mandatory)

CODE	DESCRIPTION	DIMENSIONS (WxDxH) mm
CSF-60E	Work surface made of toughened glass Emalit with a thickness of 6 mm (Hood width 600 mm)	584x584x6
CSF-90E	Work surface made of toughened glass Emalit with a thickness of 6 mm (Hood width 900 mm)	884x584x6
CSF-120E	Work surface made of toughened glass Emalit with a thickness of 6 mm (Hood width 1135 mm)	1119x584x6
CSF-60H	Work surface made of HPL laminate with a thickness of 6 mm (Hood width 600 mm)	584x584x6
CSF-90H	Work surface made of HPL laminate with a thickness of 6 mm (Hood width 900 mm)	884x584x6
CSF-120H	Work surface made of HPL laminate with a thickness of 6 mm (Hood width 1135 mm)	1119x584x6
CHSCASP60	Base on wheels without shelf for Hood width 600 mm	605x605x865
CHSCASP90	Base on wheels without shelf for Hood width 900 mm	900x605x 865
CHSCASP120	Base on wheels without shelf for Hood width 1135 mm	1140x605x 865
CHSCASP60P	Base on wheels with shelf for Hood width 600 mm	605x605x865
CHSCASP90P	Base on wheels with shelf for Hood width 900 mm	900x605x 865
CHSCASP120P	Base on wheels with shelf for Hood width 1135 mm	1140x605x 865
PE100	Wall socket for wall panelling under the base	-
HOOD/LUM	External lighting	-
CSAS	Activated charcoal filter for solvents (pre-filter included)	510x405x60
CSBE	Activated charcoal filter for acids (pre-filter included)	510x405x60
CSMP	Activated charcoal filter for solvents and acids (pre-filter included)	510x405x60
CSPF	Pre-filter	510x405x15
CSPO	Suction manual pump for colorimetric check	-
CSPO/AA	Kit of 10 colorimetric tubes - Ac. Acid 1-80 ppm - for corrosion test*	-
CSPO/AC	Kit of 10 colorimetric tubes - Acetone No. 151 - for organic test*	-

*There are other colorimetric tubes available: please feel free to contact us

Hoods CHEMIHOOD with connection

Certified according to standard EN61010-1



CSF-001+CHSCA60

The economic solution to handle small quantities of chemicals safely



→ TECHNICAL FEATURES:

- Hood body comprising a moulded board made of acrylic methacrylate with front opening to access the volume of work.
- Motor housing made of electrogalvanized cold pressed and bent, then painted steel sheet EF P01 with a thickness of 10/10mm
- Antistatic extraction motor made of polyamide and reinforced fiberglass, resistant to corrosion
- Extraction rate: 200³/h max
- Electric power supply: 220/230V - 50Hz
- Outlet diameter of 125 mm
- Internal thermal protection IP44 according to standard DIN40050
- Protective fuse 5x20 mm, 1A
- Absorption 31W
- Alternative solution with filters HEPA and activated charcoal as standard
- Standardized pictogram signalling according to the use of hazardous substances

→ HOODS CHEMIHOOD

CODE	DESCRIPTION	EXTERNAL DIMENSIONS (WxDxH) mm	INTERNAL DIMENSIONS (WxDxH) mm	OPENING DIMENSIONS (WxH) mm	Weight (kg)
CSF-001	Fume hood W600 mm	600x600x500+300 (motor)	550x550x500	440x480	35
CSF-002	Fume hood W1200 mm	1200x600x500+300 (motor)	1150x550x500	800x480	45
CSF-004	Fume hood W600 mm with filter HEPA and activated charcoal	600x600x500+300 (motor)	550x550x500	440x480	35
CSF-003	Fume hood W1200 mm with filter HEPA and activated charcoal	1200x600x500+300 (motor)	1150x550x500	800x480	45

→ INTERNAL EQUIPMENT (optional)

CODE	DESCRIPTION	DIMENSIONS (WxDxH) mm
CSH004	Work surface made of stainless steel for hood 600 mm	550x550x40
CSH004V	Work surface made of painted steel for hood 600 mm	550x550x40
CSH005	Work surface made of stainless steel for hood 1200 mm	1150x550x40
CSH005V	Work surface made of painted steel for hood 1200 mm	1150x550x40
CHSCA60	Base on wheels two of which are auto-locking with laminated work surface made for hood 600 mm	750x650x870
CHSCA120	Base on wheels two of which are auto-locking with laminated work surface made for hood 1200 mm	1200x650x870
CSH002	Activated charcoal filter for hood 600 mm	-
CSH003	Activated charcoal filter for hood 1200 mm	-
CSH007	Filter HEPA	-
GFKIT125	Kit of connections comprising 1 meter of hose, diam. 125 mm and 2 attachment clamps	Ø 125 mm

Storage of phytosanitary products

According to DPR 290/01

All phytosanitary products should be stored in a room:

- used for this purpose
- separately from food products for the human or animal diet or from other hazardous substances
- key locked so that no foreign person, above all children, can access the room
- aerated and ventilated
- free of moisture

→ REMINDER OF THE SAFETY RULES CONCERNING THE STORAGE OF PHYTOSANITARY PRODUCTS

The storage of phytosanitary products far from water courses and points, sensitive crops, inhabited areas, areas of food storage (food for animals, greens...), areas with a high concentration of persons, power lines.

Provide for easy access to the room by delivery vans and for waste disposal.

The storage area for phytosanitary products might be a bungalow, a container or a safety cabinet.

They should be:

- aerated and ventilated
- key locked
- the door should open outwards
- the ground should be waterproof (retention floors, retention pallets, retention bins), lighting should be appropriate
- the electrical system should be in compliance
- provide the door of the bungalow, container or cabinet with a sign indicating all safety instructions, standardized hazard pictograms
- provide for a fire extinguisher outside the stocking area and a suitable first aid kit
- provide for a stock of absorbent material in close proximity, should any accidental leakage or spillage occur



→ HOW TO STORE THE PHYTOSANITARY PRODUCTS PROPERLY

- Store the products by family and keep incompatible products separated from each other
- Identify and make an up-to-date list of the homologated products stored
- Display all necessary information for prevention which appears on the safety data sheet
- Store only materials which reserved for the phytosanitary use
- Provide for enough absorbent materials (example: absorbent mat)
- Use grids to isolate the products of the retention tray
- Provide the room with a first aid kit: eyewash equipment, first aid kit...
- Display the emergency numbers in close proximity
- Store empty packaging in a collection tank for treatment by a specialized company
- Keep the personal protective equipment and the stock of filter cartridges in a specific room
- Provide for an eyewash station and an emergency shower in close proximity but away from the storage area

Storage of phytosanitary products

According to DPR 290/01

**PRODUITS PHYTOSANITAIRES
PRODOTTI FITOSANITARI**

EN CAS D'INTOXICATION / IN CASO DI INTOSSICAZIONE

SECOURS / SOCCORSO

Pompieri	Pompieri	Emergenza	Samu	Ambulanza
18	115	112	15	118

Conforme DL 150 12/08/2012 - DPR 290/01 ITALIA



Series PHYTO

Storage cabinets for pest control products
and other agricultural products



CS600V



CS900V

Handy
and cheap



CS60050V



CS90050V

→ TECHNICAL FEATURES:

- Strong structure made of steel, covered in a green epoxy paint RAL 6010.
- Steel 8/10°.
- Swing doors with single wall.
- Safety key lock with 3 points for protection against theft.
- Retention shelves made of painted steel, height-adjustable.
- Prearrangement for ventilation through a Ø 125 mm flange for connection.
- According to DPR 290/01
- Standardized pictograms according to **standards ISO 3864**

→ SERIES PHYTO

CODE	DESCRIPTION	EXTERNAL DIMENSIONS (WxDxH) mm	INTERNAL DIMENSIONS (WxDxH) mm	INTERNAL EQUIPMENT	STORAGE CAPACITY*	Weight (kg)
CS600V	High cabinet with 1 door	540x450x2000	530x430x1980	3 shelves + 1 retention tray made of painted steel (max load 40 kg evenly distributed)	48	45
CS900V	High cabinet with 2 doors	1000x450x2000	990x430x1980	3 shelves + 1 retention tray made of painted steel (max load 80 kg evenly distributed)	96	65
CS60050V	Cabinet counter with 1 door	540x450x1000	530x430x998	1 shelf + 1 retention tray made of painted steel (max load 40 kg evenly distributed)	24	35
CS90050V	Cabinet counter with 2 doors	1000x450x1000	990x430x998	1 shelf + 1 retention tray made of painted steel (max load 80 kg evenly distributed)	48	45

*Approximate capacity in bottles holding 1 litre per cabinet

→ INTERNAL EQUIPMENT (optional)

CODE	DESCRIPTION	DIMENSIONS (WxDxH) mm	RETENTION VOLUME (LITRES)	STORAGE CAPACITY*
CRF600V	Additional shelf made of painted steel for cabinet with 1 door	537x415x30	6	12
CRF900V	Additional shelf made of painted steel for cabinet with 2 doors	990x415x30	12	24

*Approximate capacity in bottles holding 1 litre

→ VENTILATION (optional)

CODE	DESCRIPTION	DIMENSIONS (WxDxH) mm
DIAM125BP	Fresh air box with filter holding box for high cabinet with 1 or 2 doors- inlet/outlet Ø: 125 mm (filter excluded)	290x290x270
RE1000	Fan flow controller (to be ordered with the fan DIAM125BP)	-
RSOL	Activated charcoal filter for motor DIAM125BP - (replacement twice every year minimum)	235x110x15
GFKIT125	Connection kit: 1 metre of flexible sheath Ø 125 mm and 2 clamps	Ø 125 mm
TIM24	Daily counter	-

*To obtain the complete list of the connection accessories, see the chapter on ventilation of this catalogue and the current price list

Ventilation Choice Guide

The importance of filter replacement

→ THE CHOICE OF VENTILATION

In order to ensure the utmost safety of workers and to preserve the safety cabinets for corrosive substances, we recommend to provide them with a ventilation system.

For networks longer than 5 metres, please contact us: we will provide you with a customized study



→ REPLACEMENT OF ACTIVATED CHARCOAL FILTERS

Activated charcoal is a microporous absorbent substance belonging to a network of fissures and pores connected to each other, which is present throughout the whole material.

Contaminant gas molecules contained in an air flow penetrate through the largest pores situated on the surface of the activated charcoal by means of a process called diffusion and move towards the inner surface of the narrowest pores. When a gas molecule hits the surface of the activated charcoal in a suitable point, an attraction occurs and the molecule gets entrapped.

Therefore, a filter is saturated when all the pores are filled with the substance to be filtrated. It becomes then inefficient and worse, **the first entrapped molecules are released by the pressure of the new molecules.**

The role of the filters inside fresh air boxes of cabinets is to hold noxious vapours that are released by the stored products inside the cabinet itself.

It is extremely important to **replace filter on a regular basis**, or at least to check their saturation level.

Ventilation system with connection



Ventilation system with recirculation



→ REFERENCES:

- **For cabinets containing solvents:**
Motor DIAM125BP + filter RSOL + connection kit GFKIT100
- **For cabinets containing chemicals:**
Motor DIAM125BP + filter RSOL + connection kit GFKIT125
- **In a system with external connection, the filter is not mandatory, his purpose is basically to protect the environment.**
- **WE RECOMMEND TO REPLACE THE FILTER 2 TO 3 TIMES A YEAR AND TO PERFORM MAINTENANCE MONTHLY**
(cleaning of cabinet, dust-removal of the filter)

→ REFERENCES:

- Motor CFN or CFNL + filter CSAS/CSBE/CSMP according to the type of stocked products
- **WE RECOMMEND TO REPLACE THE FILTER 2 TO 3 TIMES A YEAR**
- **It is also possible to check the filter saturation through a colorimetric check carried out using a suction pump. Please feel free to contact us.**

A saturated filter is an inefficient filter

In order to protect workers and environment, replace the filters on a regular basis!

It is also possible to check the filter saturation through a colorimetric check carried out using a suction pump. Please feel free to contact us.

REPLACE FILTERS ON A REGULAR BASIS AND CHECK THEIR SATURATION

VENTILATION UNITS with external connection

For cabinets containing
non-flammable chemicals



CSF120MY11

→ TECHNICAL FEATURES:

- Chamber made of reinforced fiberglass and polyamide resin
- Filter holding box included in the motor body
- Flameproof
- Antistatic
- Corrosion resistant
- Internal thermal protection IP44 according to standard DIN40050
- Extraction rate: 260 m³/h
- Electrical power supply: 220-230V/50HZ single phase
- Supplied with power supply cable
- Neoprene gasket to ensure
- Outlet diameter: 100 mm

Clogged filter = no efficient filtration of chemicals = lack of protection for workers

**As safety and health have no price,
check and replace filters on a regular basis**

The filtration box should include an activated charcoal filter

→ SERIES

CODE	DESCRIPTION	DIMENSIONS (WxDxH) mm	Weight (kg)
DIAM125BP	Fresh air box with filter holding box for high cabinet with 1 or 2 doors - outlet Ø: 125 mm (filter excluded)	290x290x270	10
CSF120MY11	Fresh air box with paneling for cabinet with 2 doors - outlet Ø 100 mm	1200x510x300	18

→ OPTIONS

CODE	DESCRIPTION	DIMENSIONS (WxDxH) mm
RE1000	Fan flow controller (to be ordered with the fan DIAM125BP)	-
RSOL	Activated charcoal filter for motor DIAM125BP - (to replace at least twice a year)	235x110x15
GFKIT125	Connection kit: 1 metre of flexible sheath Ø 125 mm and 2 clamps	Ø 125 mm - W1000 mm
GF125	1 metre of flexible sheath Ø 125 mm	Ø 125 mm - W1000 mm
SERMET125	Clamp Ø 125 mm	Ø125 mm
AC409	Rigid PVC pipe Ø 125 mm	Ø 125 mm - W1000 mm
AC419	Rigid PVC 90° elbow Ø 125 mm	Ø 125 mm
AC429	Rigid PVC 45° elbow Ø 125 mm	Ø 125 mm
AC440	Rigid PVC T-connection Ø 125 mm	Ø 125 mm
AC489	Rigid PVC manual butterfly valve Ø 125 mm	Ø 125 mm
AC457	Expulsion section with anti-bird grid Ø 125 mm	Ø 125 mm
AUM100125	Reduction 125 mm/100 mm	Ø 125 mm - Ø 100 mm
TIM24	Daily counter	-

For cabinets containing inflammable chemicals

→ TECHNICAL FEATURES:

- Steel compartment with aluminium rotor
- Filter holding box included in the motor body
- Flameproof & antistatic
- Corrosion resistant
- Internal thermal protection IP55 according to standard DIN40050
- Extraction rate: 200m³/h
- Electrical power supply: 220-230V/50HZ single phase
- Integrated filtered compartment
- Supplied with power supply cable
- Neoprene gasket to ensure tightness
- Outlet diameter: 125 mm



DIAM125BP

→ ACTIVATED CHARCOAL FILTER

Activated charcoal is a microporous absorbent substance belonging to a network of fissures and pores connected to each other, which is present throughout the whole material.

Contaminant gas molecules contained in an air flow penetrate through the largest pores situated on the surface of the activated charcoal by means of a process called diffusion and move towards the inner surface of the narrowest pores.

When a gas molecule hits the surface of the activated charcoal in a suitable point, an attraction occurs and the molecule gets entrapped.

Therefore, a filter is saturated when all the pores are filled with the substance to be filtrated. It becomes then inefficient and worse, the first entrapped molecules are released by the pressure of the new molecules.

The role of the filters inside fresh air boxes of cabinets is to hold noxious vapours that are released by the stored products inside the cabinet itself.

It is extremely important to replace filter on a regular basis, or at least to check their saturation level.

→ SERIES

CODE	DESCRIPTION	DIMENSIONS (WxDxH) mm	Weight (kg)
DIAM125BP	Fresh air box with filter holding box for high cabinet with 1 or 2 doors- inlet/outlet Ø: 125 mm (filter excluded)	290x290x270	11
CSF100BPAMY11	Fresh air box ATEX with power cable and filter box - outlet diam. 125 mm	350x370x500	11

→ OPTIONS

CODE	DESCRIPTION	DIMENSIONS (WxDxH) mm
RE1000	Fan flow controller (to be ordered along with fan DIAM125BP)	-
RSOL	Activated charcoal filter for motor DIAM125BP - (to replace at least twice a year)	235x110x15
GFKIT100	Kit for external connection (1 metre of flexible sheath Ø 100 mm and 2 clamps)	Ø 100 - W1000 mm
GF100	1 metre of flexible sheath Ø 100 mm	Ø 100 mm - W1000 mm
SERMET100	Clamp Ø 100 mm	Ø 100 mm
AC408	Rigid PVC pipe Ø 100 mm	Ø 100 mm - W1000 mm
AC425	Rigid PVC 90° elbow Ø 100 mm	Ø 100 mm
AC428	Rigid PVC 45° elbow Ø 100 mm	Ø 100 mm
AC488	Rigid PVC manual butterfly valve Ø 100 mm	Ø 100 mm
AC456	Expulsion section with anti-bird grid Ø 100 mm	Ø 100 mm
AC443	Rigid PVC T-connection Ø 100 mm	Ø 100 mm
AUM100125	Reduction 125 mm/100 mm	Ø 125 mm - Ø 100 mm
TIM24	Daily counter	-

Fresh air box with filtration

Certified according to standard NFX15-211



All toxic vapours released by the storage of chemicals are removed, thus ensuring cleaned air inside the lab.

Easier and cheaper to implement, this system allows the ventilation of cabinets with no need of external connections and with no issue relating to air compensation in the room.

Therefore this ventilated cabinet can be installed in any place of the lab and in close proximity to the work area.

→ WORKING PRINCIPLE OF A FILTERING VENTILATED CABINET

Noxious vapours remaining inside the storage cabinet are extracted by the fresh air box and cleaned when passing through the activated charcoal filter before being released into the atmosphere. The filtration of vapours should be performed in a specific manner by choosing the suitable activated charcoal filter.

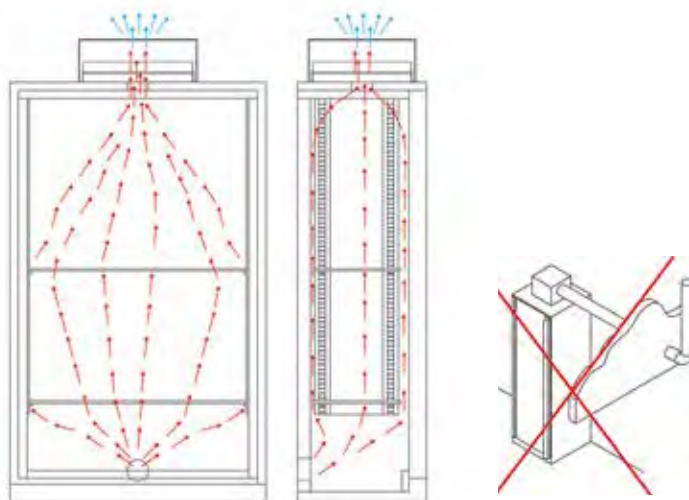

→ ACTIVATED CHARCOAL FILTER

Activated charcoal is a microporous absorbent substance belonging to a network of fissures and pores connected to each other, which is present throughout the whole material.

Contaminant gas molecules contained in an air flow penetrate through the largest pores situated on the surface of the activated charcoal by means of a process called diffusion and move towards the inner surface of the narrowest pores. When a gas molecule hits the surface of the activated charcoal in a suitable point, an attraction occurs and the molecule gets entrapped.

Therefore, a filter is saturated when all the pores are filled with the substance to be filtrated. It becomes then inefficient and worse, **the first entrapped molecules are released by the pressure of the new molecules.**

The role of the filters inside fresh air boxes of cabinets is to hold noxious vapours that are released by the stored products inside the cabinet itself.

It is extremely important to replace filter on a regular basis, or at least to check their saturation level.

Technical drawings

- Sizes: W550 x D500 x H220 mm
- Weight: 13 Kg

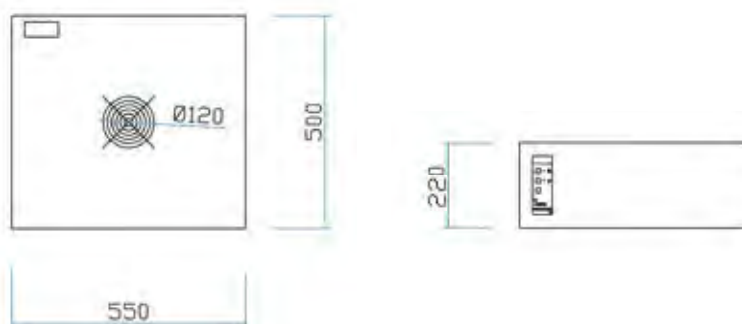

→ TECHNICAL FEATURES:

Cabinet ventilation

- Electrogalvanized steel structure 10/10 mm, covered in a light blue epoxy paint
- Axial fan
- Flow rate: 100 to m³/h
- Voltage/frequency: 220 volts/50Hz, protection IP44
- Acoustic level 45dB
- Complying with the standard ISO 3744
- Retention capacity CCL4 on a 7000 g-filter (in compliance with the efficiency level defined by the standard AFNOR NFX 15-211) or maximum rejection of 50% of the average exposure value of the product)



Control Microprocessor AC5500

- ON/OFF switch with light indicators for motor proper working
- LED visual and acoustic working hour meter
- Alarm indicator of filter saturation every 60 working hours
- Speed measurement of the air passing through the filter
- Possibility of programming the suction time (12h or 24h)

Manual sampling pump (optional)

- It allows air sampling and the colorimetric analysis in order to assess the activated charcoal filter saturation.

**Clogged filter = no efficient filtration of chemicals
= lack of protection for workers**

**As safety and health have no price,
check and replace filters on a regular basis**

The filtration box should include an activated charcoal filter



→ FRESH AIR BOX WITH FILTRATION

CODE	DESCRIPTION	DIMENSIONS (WxDxH) mm
CFN	Fresh air box with molecular filtration according to standard NFX15-211, with visual and acoustic alarm	550x500x220
CFNL	Molecular filtration box manufactured, without alarm	550x500x220
CFNCO	Hour counter for CFN	
CFNUB	Certified box with filtration certified according to standard NFX15-211 for underbench cabinets, provided with wheels, 2 ventilation outlets, with acoustic and visual alarm.	400x500x650
CFNUBL	Box with filtration built for underbench cabinets, provided with wheels, 2 ventilation outlets	400x500x650
ADMY11CFN	Adapter for CFN box for cabinet C3 and C4 (CS343-342-344MY11)	-
CSAS	Activated charcoal filter for solvents (pre-filter included)	510x405x60
CSBE	Activated charcoal filter for acids (pre-filter included)	510x405x60
CSMP	Activated charcoal filter for solvents and acids (pre-filter included)	510x405x60
CSSP	Activated charcoal filter on request	510x405x60
CSPF	Pre-filter	510x405x15
CSPO	Suction manual pump for colorimetric check	-
CSPO/AA	Kit of 10 colorimetric tubes - for corrosion test*	-
CSPO/AC	Kit of 10 colorimetric tubes - for organic test*	-

*There are other colorimetric tubes available: please feel free to contact us

@CHEMISAFE, @CFN and @DIAM125BPMY11 NEW SMART ASPIRATION SYSTEMS!



Multiple systems
can be controlled



Multiple people can
control the systems

→ **TECHNICAL FEATURES:**

New Smart Aspiration Systems!

- It is possible to check and manage the status of the aspiration system of Chemisafe Safety storage cabinets at any time and in any place with a simple touch on your smartphone through the eWelink App.
- No time or distance limit

Possibility to set up the programming time for the automatic control:

- Single, on repeat and countdown timer (to detect the moment the filter needs to be changed) can be set, allowing to check the aspiration system automatically.

Possibility to share the control of the device:

- It is possible to share the control of the aspiration system with other people, so that everyone can turn the aspiration on and off through remote connection.



The new ventilation systems for Safety Cabinets @CHEMISAFE, @CFN and @DIAM125BPMY11 are provided with a visual and audio alarm, with non return valve, in case of air flow interruption.



→ **NEW SMART ASPIRATION SYSTEMS**

CODE	DESCRIPTION	DIMENSIONS (WxDxH) mm
DIAM125BPWF	Electro exhaust fan in metal box, on/off switch, fusibles and power cord. APP controlled: timer, filter replacement indicator	290x290x270
CSF100ABPMY11WF	ATEX Electro exhaust fan in metal box, on/off switch, fusibles and power cord. APP controlled: timer, filter replacement indicator	350x370x500
RSOL	Active Carbon Filter	245 x 110 x 20
ALTERNATIVE SOLUTION		
CFNWF	Molecular filtration system, certified according to NFX15-211 (filter not included) APP controlled: timer, filter replacement indicator	
CFNLWF	Molecular filtration system (filter not included) APP controlled: timer, filter replacement indicator	
CSAS	Filter for SOLVENTS (for CFN)	510 x 400 x 60
CSBE	Filter for ACIDS (for CFN)	510 x 400 x 60
CSMP	Filter for ACIDS and SOLVENTS (for CFN)	510 x 400 x 60
CSPF	Prefilter for dust (spare part for CFN)	

SAFETY SHELVING made of modular epoxy steel

Please feel free to contact us
to work on your project together



→ TECHNICAL FEATURES:

- Strong and modular structure made of galvanized steel, covered in a nontoxic and anti-scratch epoxy resin.
- Standard colour: RAL7035
- Perforated shelves made of polypropylene, corrosion resistant
- High capacity: permitted maximum load per shelf: 150 to 205 kg evenly distributed according to the shelf width
- Standard models H2000 mm with 4 shelves
- Optional retention tray
- Optional wall mounting system
- Robustness and quality: product solidity during the whole production line

Patented self-locking attaching system
allowing an easy and quick assembly
with just one worker,
with no need of screws and tools

→ MAXIMUM HYGIENE

- Ideal for use in the food, chemical, pharmaceutical and hospital sectors
- Very easy withdrawal of shelves
- Shelves can be washed in the dishwashing machine, thus ensuring the utmost hygiene
- Complying with the standard HACCP



→ MODULAR SHELVING

	BASE ELEMENT - H 2000 mm			NEXT RIGHT ELEMENT - H 2000 mm		
	W900 mm	W 1000 mm	W 1200 mm	W 850 mm	W 950 mm	W 1150 mm
D 400 mm	AF3LSF4820	AF3LSF4920	AF3LSF41120	AF3LEF4820	AF3LEF4920	AF3LEF41120
D 500 mm	AF3LSF5820	AF3LSF5920	AF3LSF51120	AF3LEF5820	AF3LEF5920	AF3LEF51120
D 600 mm	AF3LSF6820	AF3LSF6920	AF3LSF61120	AF3LEF6820	AF3LEF6920	AF3LEF61120

Other sizes on request

TRUST US **WITH YOUR PROJECT!**



Our design department is at your disposal to optimize the available space and fulfil your standard or custom-made orders..

- Pre assembly of ladders according to the customer's requirements
- Use-friendly labelling thanks to a label showing the content and references of the project
- Space optimization by removing the uprights from angles

Please feel free to contact us to work on your project together

SAFETY SHELVING non modular stainless steel



CS9501

→ TECHNICAL FEATURES:

- Stainless steel structure
- Sizes: 1200 x 500 x 1800 (W x D x H)
- Weight: 53 kg approx.
- 4 retention shelves allowing the recovery of chemicals in the event of accidental spillage
- Retention shelves for the chemical recovery in case of accidental reversal
- Number of shelves: 4 maximum
- Retention capacity: 13 litres
- Shelving equipped with levelling jacks

GENERAL CONDITIONS OF SALE

October 2021

GENERAL INSTRUCTIONS

- 1 - The placing of orders implies the purchaser's acceptance of these general conditions of sale. The nullity of one of these general conditions of sale will not affect the validity of all other conditions.
- 2 - The orders of the purchaser, that are contrary to these general conditions of sale, may not be enforced against us, unless this has been accepted in writing on our part.
- 3 - Equipment and materials that we produce and supply are for users of hazardous substances under the sole liability of users. Our products comply with the Italian and European standards in force. Should customers decide to use these products outside the European Union, they need to check the compliance with the regulations of the destination country. We accept no liability for improper use other than the original one by the users or in case of non-compliance with the local standards

PRODUCTS AND CATALOGUE

- 1 - Features, dimensions, weights, colours, photos and information contained in the catalogue, prices and notes are just indicative and do not place us under any obligation. We reserve the right to modify, without notice, our materials, both in aspect and size, with no change in their intrinsic quality. All technical specifications contained in our current catalogue cancel and replace those published previously. Despite our efforts, some errors may escape our attention. The customer could not assert against us that he was not aware of this. According to article 18 of the decree 2005-829 dealing with the composition of electrical and electronic equipment and the disposal of wastes due to this equipment, all liabilities relating to the organisation and funding of waste removal and treatment are transferred to the customer and he shall be deemed responsible for that.
- 2 - Technical researches and recommendations have been done voluntarily and are indicative. They do not incur the liability of CHEMISAFE and do not constitute an element of execution. It is the users' responsibility to verify them and check their compliance with the applicable general rules for this kind of execution, as well as with particular conditions of employment.

PRICES AND ORDERS

- 1 - Prices or offers specified in our catalogue and price lists are valid at the time of printing and distribution. They cancel and replace all offers and prices specified previously. All are prices are shown exclusive of taxes, in Euros, EX WORKS (Italy I-31032), unless otherwise notified in writing and subject to a significant increase in raw materials and/or currencies. For all shipments, the minimum amount of a bill is 100 Euros, excluding taxes. For order below this amount, a flat billing rate of 20 Euros excluded taxes will be applied.
- 2 - Orders should be sent to us in writing (e-mail, telefax or mail) according to our catalogue and current prices or quotation to the client. Orders shall be placed only upon acceptance and validation by CHEMISAFE, on the acknowledgment of receipt by the seller. All claims concerning the conditions of execution of orders shall be presented upon receipt of the acknowledgment of receipt, before delivery.
- 3 - All orders are firm and irrevocable for the Purchaser from the acceptance by CHEMISAFE.

No order shall be cancelled by the Purchaser, unless prior consent by the Seller, and in this case, the Seller reserves the right to claim, as compensation, the amount of the purchased or work-in-progress goods.

DELIVERY TIMES

- 1 - The dates of product availability noted on our acknowledgment of order receipt and on our quotation are given in good faith but without any claim for compensation or cancellation resulting therefrom if not met.

- 2 - Our delivery dates start from the date of the acknowledgment of order receipt.
- 3 - Stipulations concerning orders and specifying for example the penalties for late delivery or others might be applied only upon our nominative acceptance in writing.
- 4 - If the purchaser is not able to receive our delivery on the availability date indicated on the acknowledgment of order receipt, we will take all necessary measures to store the goods under the best possible conditions. The corresponding fees will be charged to the purchaser. Delivery shall be made only if the customer is up to date with his obligations towards our company and if the particular conditions accepted by the customer and CHEMISAFE are met.

TRANSPORT AND DELIVERY

- 1 - Unless otherwise agreed in writing, our products are sold EX WORKS Italy (I-31032).
- 2 - CHEMISAFE assumes responsibility for the necessary packaging to prevent all damages under normal transport conditions. If CHEMISAFE assumes responsibility for the arrangement of the transport agreement, shipping fees will be invoiced additionally and transport will be carried out for the best interests of the customer but without any commitment or liability by CHEMISAFE. In order to know the transport fees, please refer to the quotation drawn up by CHEMISAFE or the Price List 2017. The customer shall inform about any limitation and/or restriction that would not allow the carriers to perform their task correctly.
- 3 - Our goods travel at the recipient's risks (art. L133-3 of the Commercial Code). The recipient of goods undertakes, upon receipt, to:
 - a/ check the conditions and quantity of the received goods by opening packages in the presence of the deliverer and before signing the carrier's dispatch note or delivery note.
 - b/ enter precise reservations, in the event of damage or missing products, on the transport receipt specifying their nature in a very detailed manner.
 - c/ notify carrier of any damage or missing product by registered letter with acknowledgement of receipt within 48 hours after the date of receipt of the goods, in compliance with article L 133-3 of the Commercial Code.Failure to respect these instructions prevents all actions against the Seller and the Carrier.
- 4 - For any goods delivery, refused without a valid reason or impossible to carry out for various reasons: wrong address, inadequate buildings, lack of a responsible receiving person, non-compliant delivery time, or any other circumstance beyond our control, the price of the new delivery of goods will be invoiced again.
- 5 - Installation and construction prices are not included in our offer, unless previously agreed, and will be the object of a complementary quotation.
- 6 - Goods remain the property of CHEMISAFE until the price has been paid in full, but the Purchaser will become liable only upon delivery of goods or their installation.

LACK OF CONFORMITY AND CLAIMS

- 1 - All claims concerning a lack of conformity to the order (model, delivered quantity, damaged product) should be notified by registered letter with acknowledgement of receipt within 7 days after the date of receipt of goods. Using the goods entails the waiver by the Purchaser of all claims for lack of conformity.

2 - No return of goods will be accepted without prior authorization by the Seller. Return, prior agreement with CHEMISAFE, shall be carried out at the expense and risk of the Purchaser in the original package. Returned goods will give rise to a credit note after checking their perfect conditions. A flat discount of 25% will be applied over one month.

3 - Returned goods shall be only standard models. CHEMISAFE will not accept any custom-made product.

WARRANTY

The warranty shall start as of the delivery date of goods (Invoice in lieu of warranty) and does not include consumable parts or routine maintenance and adjustments indicated in the user's guides supplied together with the equipment.

Our warranty applies only in case of defects in conception or a hidden defect and is strictly limited to the replacement of materials and components recognised as faulty by our quality and technical service, the only qualified to judge.

This warranty shall not be applied in the event of storage, use or maintenance by the user non complying with the use or instructions for use or if goods have been damaged by the user or third parties or if the goods have been modified or repaired by the user or third parties without our authorization in writing, nor in case of normal wear or in case of non-payment of all or part of the cost of materials on the due date. The warranty appliance will not have the effect of extending its term. Our warranty ceases if the purchaser fails to notify the noted defect within 7 days after the date of detection, which date he should be able to prove.

Warranty does not include:

- Normal wear of the product,
- Use of consumable parts of other brands,
- Product transformation or incompatibility with other materials,
- Improper or non-compliant use of the product with regard to its specifications or negligent storage or maintenance carried out by the customer,
- Improper installation of the product,
- Damages caused by corrosion.

1 - Safety cabinets: the warranty period is THREE YEARS for cabinets with ventilation and ONE YEAR for cabinets without ventilation.

2 - Ventilation units and filtering boxes: the warranty period is ONE YEAR.

CHEMISAFE reminds that for ventilation units DIAM125BP, EOF100ABPMY11, K89013BP, K89190 and K89191, the warranty applies only if they are provided with an external connection by means of a sheath or pipe supplied by the Customer or by CHEMISAFE.

CHEMISAFE also reminds that:

- If necessary, filters should be replaced every 3 to 4 months in case of regular use.
- filters should be replaced immediately in case of accidental spillage of a "so called hazardous" substance inside the cabinet.
- Cabinets should be placed in a clean and aerated room.
- Cabinets should be cleaned (maintenance, dust removal,...)

We recommend following the instructions provided on the maintenance sheet and applying the described procedure for dust removal of the filter.

3 - Fume and connected hoods: the warranty period is ONE YEAR.

4 - Emergency shower and others: the warranty period is ONE YEAR.

CHEMISAFE declines all liabilities in case of improper use of the supplied goods other than the original one. The users are solely responsible for any handling, experiences gained and handled products (toxic, radioactive

or inflammable) by means of the equipment by CHEMISAFE. These users shall pay the utmost care when using such products in order to comply with legal requirements, particularly as regards personnel safety, and provisions relating to health and safety at work and accident prevention

INTELLECTUAL PROPERTY

Photographs, diagrams, logos and texts shown on our commercial documents in paper or digital form, including websites, registered or not at an Intellectual property office, are the exclusive property of CHEMISAFE. Any infringement of the intellectual property will result in legal proceedings. All brands and logos shown and mentioned in our technical and commercial documents are filed and belong to their respective owner.

PAYMENT CONDITIONS

1 - Sales in Italy & overseas territories and departments: goods shall be paid within 30 days at the latest by cheque, bank transfer or accepted and domiciled bill (if not otherwise agreed and confirmed on quotation previously).

Equipment sold to a new customer is payable in cash as first order.

The items addressed to the customer must return to CHEMISAFE, whether accepted or not, under pain of being sued for damages..

2 - Export sales: all settlements corresponding to exported products beyond Italian borders will be performed as follows:

- For the first order: 100% pre-payment or documentary remittance versus payment.

PAYMENT DELAY

According to article L441-6 of the Commercial Code, any payment delay will result, at the supplier's discretion and from the first days of delay, in:

- The application of a delay interest equal to the most recent refinancing rate of the European Central Bank plus a further ten points (law on modernisation and economy – LME – No. 2008-776 of 4 August 2008);
- The application of a flat-rate allowance for recovery costs of 40 euros (European Directive 2011/7 of 16 February 2011, law 2012-387 of 22 March 2012 and decree 2012-1115 of 2 October 2012),
- If recovery costs are higher than the amount of the flat-rate allowance, a supplementary compensation is applied, upon justification.

Any default of payment on the due date, as well as any refusal of acceptance of bill of exchange, upon its presentation, results, at the supplier's discretion, in the suspension or termination of all pending orders. The settlement of all partial deliveries is due to the date mentioned on the corresponding invoice and not at the date of delivery of the balance. Any deterioration in the purchaser's credit will justify the provision of a guarantee or a payment in cash, before the fulfilment of the received orders. Under no circumstances, the payments due to CHEMISAFE may be suspended or have any reduction or set-off applied to them without written authorization by CHEMISAFE.

No warranty holdback will be accepted by CHEMISAFE, unless duly agreed previously. All references to this warranty holdback in the general conditions of sale are thereby not relevant.

ATTRIBUTION OF JURISDICTION

Except otherwise agreed, in the event of any dispute arising from any order, interpretation and execution of sale agreements, which fall under the Italian law, the court jurisdiction is the commercial court of Treviso.

DELIVERY AND INSTALLATION SHEET

To fill and return by telefax to : 0039 0422 827739 or e-mail: info@chemisafe.it

COMPANY	
ADDRESS	
FLOOR No.	
CONTACT	
TELEPHONE	
ORDER REF.	
CABINET(S) REF.	

**more than 3 steps= 1 floor - ** if you order more cabinets, please notify if they are all for the same room or building*

1- DELIVERY DATE AND TIME

- The delivery will be possible from: / /
- Delivery time:
 - Morning from to
 - Afternoon from to

2- ACCESS TO BUILDING

- Possibility of delivery with a 3.5 tons truck yes no
- Flat surface yes no
- Loading dock yes no
- Forklift truck yes no

3- INSTALLATION

- Would you like a preliminary visit? yes no
- Floor (*indicate the no. of floors*)
.....
 ground f floor n°
- Goods elevator yes no
- If YES
 - Maximum capacity of the goods elevator Kg
 - Sizes of the goods elevator (cm) W..... x D..... x H.....
- If NO
 - Type of staircases (*spiral, winding, straight...*)
 - Number of landing
 - Manipulation depth minimum of 2,20 m yes no
 - Number of doors to cross
 - Door sizes (cm) W..... x H
 - Path *number of meters from exiting the elevator/staircase to the installation site*
 - Maximum floor load (Kg) Kg
 - Additional notes:

Signatory NAME:
Job:

STAMP
and signature



Authorized dealer: